

RANGE ROVER



ABOVE & BEYOND





BY APPOINTMENT TO
HM THE QUEEN
MANUFACTURERS OF
MOTOR VEHICLES
JAGUAR LAND ROVER LIMITED
COVENTRY



BY APPOINTMENT TO
HRH THE DUKE OF EDINBURGH
MANUFACTURERS OF
MOTOR VEHICLES
JAGUAR LAND ROVER LIMITED
COVENTRY



BY APPOINTMENT TO
HRH THE PRINCE OF WALES
MANUFACTURERS OF
MOTOR VEHICLES
JAGUAR LAND ROVER LIMITED
COVENTRY



ABOVE & BEYOND

Ever since the first Land Rover vehicle was conceived in 1947, we have built vehicles that challenge what is possible. These in turn have challenged their owners to explore new territories and conquer difficult terrains. Our vehicles epitomise the values of the designers and engineers who have created them. Each one instilled with iconic British design cues, delivering capability with composure. Which is how we continue to break new ground, defy conventions and encourage each other to go further. Land Rover truly enables you to make more of your world, to go above and beyond.







RANGE ROVER

Reflecting its unrivalled heritage, Range Rover takes design, comfort and craftsmanship to extraordinary new heights. As striking on the outside as it is refined within, its performance and capability are peerless. Exemplary levels of comfort and technology bring you a heightened sense of effortless sophistication and a truly first-class travel experience.

CONTENTS

INTRODUCTION

Range Rover 6

DESIGN

Exterior 11

Interior 13

Range Rover Long Wheelbase 16

PERFORMANCE AND CAPABILITY

Plug-in Hybrid Electric Vehicle 18

Engines and Transmission 22

Legendary Breadth of Capability 25

TECHNOLOGY

Infotainment 29

Connectivity 30

Audio 34

Driver Assistance 36

Efficient Technologies 42

SAFETY

Safe and Secure 44

Lighting Technology 47

VERSATILITY

Truly Flexible 48

Towing 52

SPECIAL VEHICLE OPERATIONS

SVAutobiography Dynamic 55

SVAutobiography Long Wheelbase 58

SPECIFICATIONS

Choose Your Model 62

Choose Your Engine 74

Choose Your Exterior 76

Choose Your Wheels 80

Choose Your Interior 82

Choose Your Options and Land Rover Gear 90

THE WORLD OF LAND ROVER 98

YOUR PEACE OF MIND 103

Vehicle shown is Autobiography in Byron Blue with optional features fitted.

Vehicles shown are from the Land Rover global range. Specifications, options and availability will vary and should be verified with your local Land Rover Retailer.

INTRODUCTION

INTRODUCING RANGE ROVER

SETTING NEW STANDARDS

Whether on Place du Casino, Monaco, or some muddy track in Warwickshire, England, Range Rover has always been synonymous with supreme refinement, capability and distinctive design cues such as its signature floating roofline, continuous waistline and lower accent graphic.

A more spacious interior, together with executive rear seating, offers an exemplary level of comfort for driver and passengers.

PHEV's 'whisper-quiet' powertrain combines ultimate refinement with exceptional efficiency.

To ensure outstanding performance and great fuel efficiency, our all-new 400HP 6-cylinder petrol engine incorporates Mild Hybrid Electric Vehicle (MHEV) technology. This system, along with other measures, also reduces CO₂ emissions and improves driveability. See page 23.

Whilst the level of technology, which includes Driver Assist Pack, LED lighting, the Touch Pro Duo infotainment system, full colour Head-up Display and seven-mode Terrain Response with 'Comfort' mode, delivers an even more luxurious driving experience.

We haven't set out to reimagine Range Rover, we've simply made it better.

LIGHTING TECHNOLOGY

All-round exterior LED lighting is standard. Designed to last the lifetime of the vehicle, LED lights are more energy-efficient and the quality of light produced is closer to daylight conditions, so driving at night becomes less tiring. Innovative Pixel-laser LED headlights provide the ultimate option and give the vehicle even greater presence. See page 47.

SUPREME ALL-TERRAIN CAPABILITY

Off-road driving is assured and precise thanks to All Wheel Drive. Electronic air suspension helps deliver an even more confident off-road experience as you can raise the vehicle by some 75mm. Such options as All Terrain Progress Control reaffirm your sense of composure. See pages 25-27.



COMPOSED TOWING

You can tow up to 3,500kg¹ with consummate ease and a suite of specific optional technologies such as Advanced Tow Assist ensure you can drive, manoeuvre and park with the least amount of fuss. See page 52.

POWERTRAINS

From power and sheer driving pleasure to fuel economy and refinement, there is a range of engines available including petrol, diesel, mild hybrid and plug-in hybrid: each has been optimised with Comfort and Dynamic modes to cater for all needs. All engines are equipped with Stop/Start technology and smart regenerative charging. See pages 18-23.

¹2,500kg on P400e PHEV engine, 3,400kg on SDV8 Long Wheelbase models.

²Applicable to vehicles fitted with rear Executive Class seating only.

Features and their availability may differ by vehicle specification.

For full feature and option availability please refer to the accompanying Specification and Price Guide or visit your local Land Rover Retailer.

Vehicle shown is Autobiography in Byron Blue with optional features fitted.

LUXURY ENVIRONMENT

With a sublime and beautifully appointed interior, Range Rover takes luxury to even greater heights. Rear seats now have increased recline and all seats have deeper cushioning for greater comfort, whilst optional 10" Rear Seat Entertainment with Touchscreens ensures passengers also enjoy optimum levels of entertainment. Veneers and trim finishers further enhance the sense of unmatched refinement. See pages 13-14.



INTELLIGENT VERSATILITY

The vehicle provides increased levels of versatility. Ample storage solutions include a deep centre console stowage compartment, whilst the ability to fold the rear seats means it can adapt to suit your specific needs. Intelligent Seat Cargo Mode with power recline and Convenience Fold with Remote Intelligent Seat Fold² allow you to make more of your vehicle. Automatic Access Height, Easy Loading and an optional Activity Key help ensure easy entry, exit and loading. Up to 7 x USB ports, 5 x 12V power sockets, 2 x domestic power sockets and 4G Wi-Fi ensure you can all stay connected. See pages 49-51.

Actual seats have new cushions and interlayers with softer, looser leather to optimise these features. Please refer to your Land Rover Retailer for more information.

ELEGANT REAR SEATING

Range Rover is fitted with 60:40 bench seating with load-through as standard. The option of rear Executive Class seating with a power deployable rear centre console and folding rear seats delivers exceptional five-seat versatility with the ability to provide four-seat comfort. Passenger comfort is further enhanced through features such as Extreme Passenger Seat Away and one-touch recline. Choose Long Wheelbase to enjoy an additional 192mm rear legroom. See pages 14-17.

SEAMLESSLY INTEGRATED TECHNOLOGY

Touch Pro Duo has two 10" high-definition Touchscreens to ensure you stay connected and entertained. This is complemented by the 12.3" Interactive Driver Display with configurable touch steering wheel controls and our optional second generation full colour Head-up Display. See page 29.

INTERIOR COMFORT AND WELLBEING

Command Driving Position ensures you enjoy a greater view of your surroundings and the road ahead. Optional Configurable Ambient Lighting and Enhanced Task Lighting complement the interior ambience while optional Cabin Air Ionisation provides a consistently fresh environment for all occupants. And for an even more sophisticated ride, thicker door glass and better acoustic insulation make this vehicle the quietest Range Rover ever. See pages 13 and 48.

RANGE ROVER PLUG-IN HYBRID ELECTRIC VEHICLE

Capability, performance and cutting-edge technologies are at the heart of every Land Rover. Taking our vehicles into the future, electric power now propels us into an exciting new era. Our first ever Plug-in Hybrid Electric Vehicle (PHEV) is driven by our most innovative powertrain yet: an advanced Ingenium Petrol engine and electric motor combine to give a composed and luxurious ride, with full Range Rover capability¹. With a full electric charge, PHEV is capable of managing most city commutes. Drivers can select from two driving modes to best suit their needs. See pages 18-21 for details.

Parallel Hybrid mode (the default driving mode) - combined petrol and electric drive. When in Parallel Hybrid mode, the driver can optimise battery charge or fuel economy by utilising two alternative charge management functions:

SAVE function - prevents the battery charge dropping below the level which has been selected

Predictive Energy Optimisation (PEO) function - by entering a destination in the Navigation system, the driver enables the feature, which utilises altitude data for the route selected to intelligently switch between the electric motor and petrol engine to maximise fuel economy

EV mode (Electric Vehicle) - full electric drive².

In addition to the benefits described above, an increasing number of major cities are introducing vehicle restrictions and charges from which drivers of PHEV vehicles could be exempt.

¹Please refer to the accompanying Technical Specification for full details on driveline, engine performance and fuel economy. Note that CO₂ and fuel economy figures can vary according to wheel fitment, and the lowest figures may not be achievable with the standard wheels. ²Parallel Hybrid mode will be automatically re-engaged should the driver require more power or torque than is available, or the battery drops to an insufficient level to maintain progress.

Rear loadspace capacity is reduced on P400e models, please see page 50 for more detail.

Features and their availability may differ by vehicle specification. For full feature and option availability please refer to the accompanying Specification and Price Guide or visit your local Land Rover Retailer.

Vehicle shown is Autobiography Long Wheelbase in Aruba with optional features fitted.

LOW CO₂ EMISSIONS¹

PHEV's CO₂ emissions make it our lowest emission powertrain yet. See page 18.



CABIN PRECONDITIONING

You can pre-heat or, uniquely to PHEV, pre-cool the cabin before you get into the vehicle without starting the engine, making life that bit more comfortable. See page 19.

EV RANGE

PHEV is fully capable of managing most city commutes in full Electric Vehicle (EV) mode¹. See page 18.

EASY OVERNIGHT CHARGING PHEV

PHEV can fully charge from a domestic electricity supply in as little as 7.5 hours³ so it's ideally suited to charging at home overnight. See page 18.

CHARGING SOLUTIONS

A full charge can be achieved in as little as 2.75 hours³ at home using the accessory multi-function charging cable and a dedicated wall box, or 32 amp industrial type socket. In addition, a range of charging points can be used at offices and other designated public places. See page 18.



REFINED DRIVE

Our quietest Range Rover yet, PHEV delivers a virtually silent drive in full EV mode. PHEV ensures seamless transition between the petrol engine and electric motor, delivering optimal refinement. See page 19.

NO COMPROMISE ON CAPABILITY AND PERFORMANCE

It is fully capable of handling off-road situations such as wading and rock crawl. Its on-road performance is equally remarkable, delivering additional power when you need it most¹. See page 19.

INCONTROL CONNECTIVITY

With the Protect and Remote Premium features, a range of functions are available through your smartphone device, from enabling the driver to view charge status, to remote operation of the vehicle's climate systems. See pages 30-32.

SEAMLESS DESIGN

Integrating the charging port into the front grille provides easy connection without compromising the vehicle's iconic design. See page 18.

³Charging times will vary by power supply and charging solution. Please refer to landover.co.uk for further information.



DESIGN

EXTERIOR

With its floating roof, continuous waistline and lower accents, Range Rover's silhouette is recognised around the world. Those commanding looks have been given an even more contemporary profile. The front grille signals a more prominent appearance, whilst the clamshell bonnet, formed of a single sheet of aluminium, is now smoother and longer to augment the vehicle's more formal, upright profile. The front bumper – including vent finishers, side vent graphics, side accent graphics and integrated exhausts – helps advance the vehicle's effortless design. A choice of Atlas or Satin body-coloured side graphics, optional design packs and new wheel designs add further appeal, whilst the option of striking Pixel-laser headlights (see page 47) and rear LED lights reinforce the vehicle's distinctive features.



Features and their availability may differ by vehicle specification.
For full feature and option availability please refer to the accompanying
Specification and Price Guide or visit your local Land Rover Retailer.
Vehicle shown is Autobiography in Byron Blue with optional features fitted.



INTERIOR

Sumptuously designed, Range Rover's interior is a tranquil haven. Effortlessly comfortable, superbly appointed and finished with a forensic eye for the details, every facet of the interior has been designed and engineered to deliver class-leading comfort for all occupants.

Thanks to Range Rover's unique Command Driving Position, the driver continues to enjoy an enhanced view of the road ahead, but now does so in even greater comfort than before. Cosseted in premium materials such as Semi-Aniline leather, wide seats and deep cushioning with soft foam interlayers help create the most luxurious environment. Combined with enhanced seat functionality, including the optional upper seat shoulder support and 'Hot-Stone' massage, along with intuitive controls using the door mounted seat control switches, the interior of Range Rover is the ultimate in refinement.

Seamlessly integrated technologies built around the Touch Pro Duo Touchscreens and Interactive Driver Display embody our design ethos; cleaner, crisper lines and fewer dials - delivering an uncluttered console that doesn't distract the driver. Veneers and luxury finishers amplify the vehicle's refined design cues, whilst enhanced Configurable Ambient Interior Lighting with a choice of ten colours adds greatly to the overall sense of calm. Additional integrated stowage solutions including a centre console deep stowage compartment, and other optional features such as the front centre console refrigerator compartment confirm a purity of craft everywhere you look and touch.

No matter how far you travel in a Range Rover, you'll always arrive as refreshed as when you set out. It's not where you go, it's how you get there.

Features and their availability may differ by vehicle specification and market. For full feature and option availability please refer to the accompanying Specification and Price Guide or visit your local Land Rover Retailer.

Interior shown is Autobiography in Navy/Ivory with optional features fitted.



Everyone who travels in Range Rover does so in the utmost comfort and style. Refinement is everywhere you look and in everything you touch; nothing exemplifies this better than the rear Executive Class seating, standard on Autobiography.

As with the front, the rear also features wider seats with deeper cushioning. The rear Executive Class seats take this to another level. When lowered, a power deployable centre console with premium veneer finishers and clever stowage solutions integrates seamlessly with the two outer passenger seats, creating a luxury four-seat environment. And at the touch of a button, Extreme Passenger Seat Away will adjust the front passenger seat forward to maximise the rear passenger's space and forward visibility, whilst the extended recline and integrated side cushions mean the passenger can adjust their seat into their optimum position.

Optional Executive Class Comfort features, including adjustable bolsters, upper seat shoulder support, headrest pillows and 'Hot-Stone' massage further enhance the rear passenger's journey. Whilst additional Executive Class Comfort Plus features, such as heated armrests, heated calf rest and a footrest with a dedicated area to warm your feet create a truly luxurious environment.

When you require increased versatility, simply retract the power deployable centre console to reveal a centre seat for a third occupant. Or, fold your rear Executive Class seats forward to maximise your loadspace: you can do so even when you're not in the vehicle using the Remote Intelligent Seat Fold application.

Other available features include optional Rear Seat Entertainment with 10" Touchscreens, Connect Pro connectivity with 4G Wi-Fi and Comfort Controller Remote app for greater control of features such as seat massage, heating and cooling, and personal climate settings. Enhanced Task Lighting is provided as standard and comes with user selectable modes, including a bright light and a warm light setting for a more relaxed environment, making Range Rover the perfect partner for your journey.



Actual seats have new cushions and interlayers with softer, looser leather to optimise these features. Please refer to your Land Rover Retailer for more information.

Features and their availability may differ by vehicle specification and market. For full feature and option availability please refer to the online configurator, Specification and Price Guide or visit your local Land Rover Retailer.

Interior shown is Autobiography Long Wheelbase in Ebony/Vintage Tan with optional features fitted.



Rear Executive Class seating with power deployable centre console stowed.



Rear Executive Class seating with power deployable centre console deployed.

Interior shown is Autobiography in Navy/Ivory with optional features fitted.



RANGE ROVER LONG WHEELBASE

Range Rover Long Wheelbase is instantly recognisable, superbly engineered and beautifully appointed. Featuring a panoramic roof as standard, this body style is characterised by a distinctive 'L' badge mounted behind each front wheel arch. The exterior is extended by 200mm to facilitate an even more luxurious environment inside.

The definitive luxury SUV, the Range Rover Long Wheelbase has an additional 192mm of interior floorspace for even more passenger legroom and comfort.

Standard features include an added deep centre stowage compartment at the rear of the front centre console, electric rear side window sunblinds, Configurable Ambient Interior Lighting and illuminated treadplates. With features such as Four-zone Climate Control enabling personalised temperature control through an additional climate unit, and optional Cabin Air Ionisation to improve the air quality within the cabin, passengers in the Range Rover Long Wheelbase can create their own tranquil haven.



Select the rear Executive Class Comfort Plus seats and not only do you get all the luxury features of the Standard Wheelbase, including Extreme Passenger Seat Away, heated armrests and 'Hot-Stone' massage, you also get an additional heated calf rest - one for each side behind both driver and passenger. And as with every Range Rover, the superbly crafted space is accompanied by the discerning use of the finest materials.

In Range Rover Long Wheelbase, every last detail combines to deliver the highest levels of luxury and refinement.



Actual seats have new cushions and interlayers with softer, looser leather to optimise these features. Please refer to your Land Rover Retailer for more information.

PERFORMANCE AND CAPABILITY

PLUG-IN HYBRID ELECTRIC VEHICLE



Designed and engineered for an increasingly carbon conscious world, our Plug-in Hybrid Electric Vehicle (PHEV), the P400e, delivers a dynamic driving experience with exceptional Range Rover capability both on and off-road.

P400e uses the combination of an advanced 2.0 litre 300HP Si4 Ingenium Petrol engine supported by a high-capacity 105kW electric motor to deliver a combined output of 404HP. The electric motor can either supply its power in parallel with the engine, or drive the vehicle in the manually selectable Electric Vehicle (EV) mode. The large 13kWh capacity battery gives the vehicle an all-electric range from a full charge, capable of managing most city commutes¹ with zero tailpipe emissions.

The P400e powertrain has been integrated seamlessly into the vehicle's design. The charging point is discreetly located in the front grille, which makes connection to a power supply both convenient and easy while lending itself to routine overnight home charging.

The battery can be fully charged in as little as 7.5 hours² using the home charging cable supplied as standard. When rapid charging, a full charge can be achieved in as little as 2.75 hours² at home using a dedicated wall box or 32 amp industrial type socket, or at a range of public charging points using a public charging cable. For charging away from home, the cable can be stored in the vehicle's loadspace using a purpose-designed storage case and retention system.

¹Please refer to the accompanying Technical Specification for full details on driveline, engine performance and fuel economy. Note that CO₂ and fuel economy figures can vary according to wheel fitment, and the lowest figures may not be achievable with the standard wheels. ²Charging times will vary by market, power supply and charging solution. Please refer to landover.co.uk for further information.

Rear loadspace capacity is reduced on P400e models, please see page 50 for more detail.

Vehicle shown is Autobiography Long Wheelbase in Aruba with optional features fitted.

The P400e delivers an exceptionally refined experience. The electric motor can produce its maximum torque from standstill and delivers a virtually silent drive. If engine torque is required, the system uses the Integrated Starter Generator (ISG) for virtually instant starting, enabling engine torque to be perfectly blended with electric motor torque, smoothly delivering the driver's demand using the hybrid integrated transmission.

Off-road capabilities are uncompromised and in some circumstances enhanced. Unlike any other plug-in hybrid vehicle, P400e matches the 900mm wading depth³ of Range Rover fitted with a conventional engine, and the additional torque provided by the electric motor at low speed is an advantage in a variety of off-road situations.

The combination of the instant torque from the electric motor with that from the highly efficient direct injection petrol engine delivers a torque profile normally associated with large capacity petrol or diesel engines, providing exceptional on-road performance¹.

For extra convenience, the vehicle can be defrosted whilst charging and journeys can begin with the cabin pre-conditioned to a comfortable temperature. The supplementary heater and air conditioning compressor - both powered by the high voltage battery - will pre-cool or pre-warm the vehicle without the requirement to start the engine when charging, or from the battery alone if sufficient charge is available.

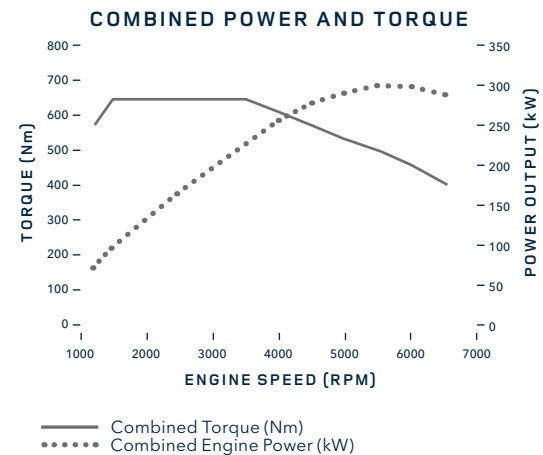

³Wading is only available when engine is engaged.



PLUG-IN HYBRID ELECTRIC VEHICLE

In Parallel Hybrid mode (the default driving mode), the electric motor supplies its power in parallel with the engine. There is a seamless transition between the 105kW electric motor and the Si4 Ingenium Petrol engine as the system smoothly starts the engine and then blends electric motor and petrol engine power together using the hybrid integrated transmission. Intelligent battery management, which charges the battery through regenerative braking even when the vehicle is coasting, ensures P400e always has sufficient charge to provide 404HP power output to deliver seamlessly impressive performance when required.

When in the default driving mode (Parallel Hybrid) the driver can optimise fuel economy or battery charge by utilising one of two alternative charge management functions:

SAVE function - manually selected through the Touchscreen, the SAVE function prevents the battery charge dropping below the level which has been selected. This allows the driver to provision for quiet, zero-emission travel at a later point in the journey. The vehicle will only use the electric motor if the battery has received a charge over and above the saved level through regenerative braking.

Predictive Energy Optimisation (PEO) function - entering a destination in the vehicle's navigation system will automatically engage the PEO function. By utilising altitude data for the chosen route, PEO intelligently switches between the electric motor and petrol engine to maximise fuel economy throughout the journey.

In addition to operating as a parallel hybrid, the large capacity battery enables the driver to operate the vehicle in **EV Mode (Electric Vehicle)** mode - manually selected by a button on the console, EV mode enables the vehicle to run solely on the electric motor using the energy stored in the battery, the ideal solution for quiet, zero-emission journeys. The system will introduce the petrol engine should the driver require more power than is available through the electric motor alone, or if the battery charge drops to an insufficient level to maintain progress.

Operation of the P400e is further enhanced through specific functionality within Remote Premium (an InControl feature, see page 32). This enables the driver to use a smartphone to view key data such as charge status as well as operating the climate functions and controlling the charging time.

- 1** 105KW ELECTRIC MOTOR

PHEV features a high-power 105kW permanent magnet synchronous electric motor to deliver power effortlessly.
- 2** INTEGRATED HYBRID AUTOMATIC TRANSMISSION

A seamless transition from EV to Internal Combustion Engine is delivered via the hybrid integrated transmission.
- 3** 2.0 LITRE INGENIUM ENGINE

Developed and engineered by Jaguar Land Rover, our aluminium 2.0 litre 300HP Si4 Ingenium Petrol engine is lighter and more efficient than predecessors.
- 4** 13KWH HIGH VOLTAGE BATTERY

The large capacity battery gives the vehicle an all-electric range, capable of managing most short commutes* from a full charge.
- 5** 7KW ON-BOARD CHARGER

The powerful 7kW on-board charger can deliver a full battery charge in as little as 2.75 hours dependent on charging station capability.
- 6** INTEGRATED STARTER GENERATOR

The Integrated Starter Generator (ISG) delivers an exceptionally refined starting of the petrol engine when required.
- 7** REGENERATIVE BRAKING

Regenerative braking uses the electric motor to harvest kinetic energy whilst braking, converting it to electrical energy that is used to recharge the high voltage battery.

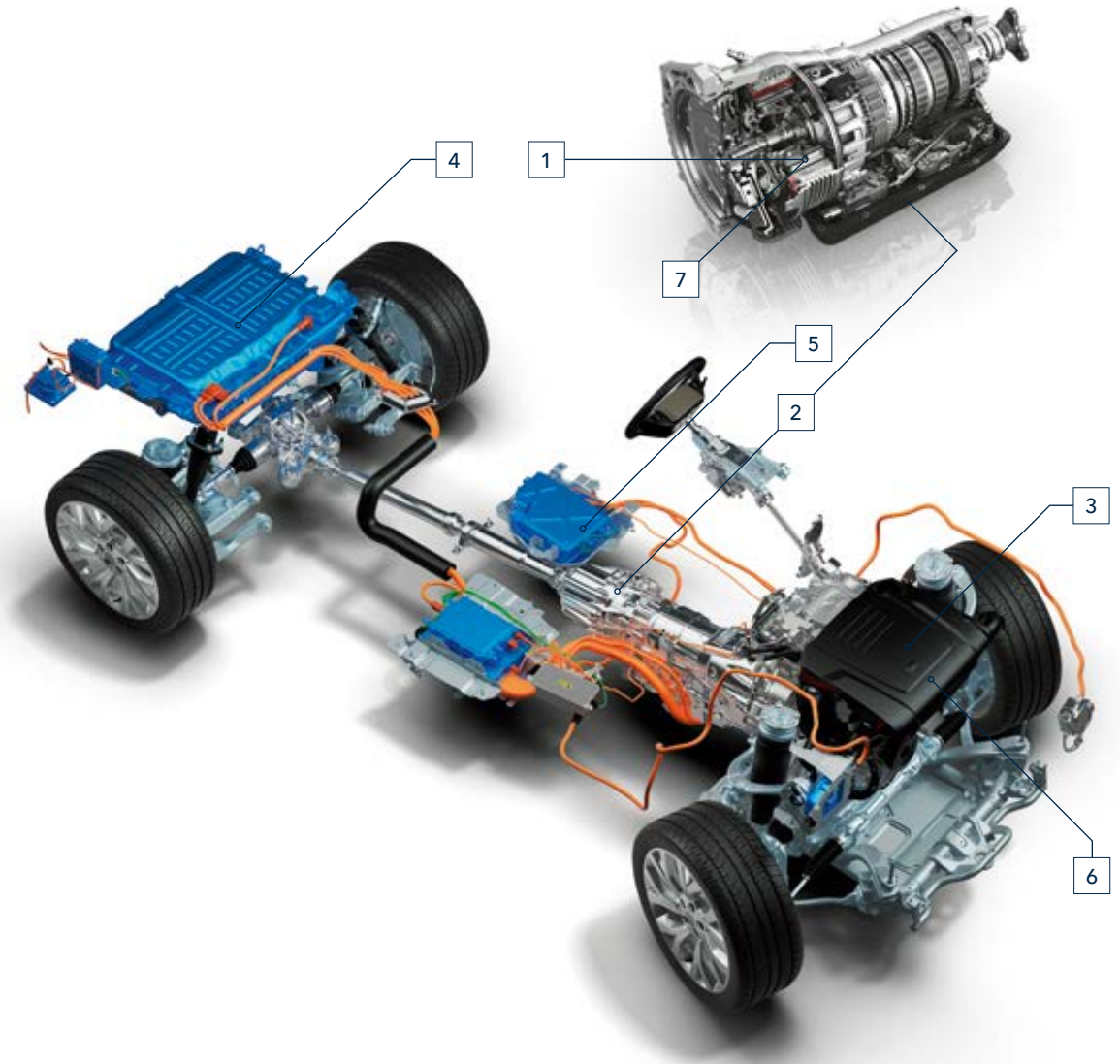

*Please refer to the accompanying Technical Specification for full details on driveline, engine performance and fuel economy. Note that CO₂ and fuel economy figures can vary according to wheel fitment, and the lowest figures may not be achievable with the standard wheels.

ENGINES AND TRANSMISSION

From power and sheer driving pleasure to fuel economy and refinement, there is a range of engines available for Range Rover and each has been optimised for specific attributes to cater for all needs. All engines are equipped with Stop/Start technology and smart regenerative charging (except P400e); this feature prioritises the charging of the battery when the vehicle is decelerating to capture wasted kinetic energy and reduce fuel consumption for maximum economy, especially during urban driving. For engine availability see pages 74-75.

8-SPEED AUTOMATIC TRANSMISSION

All diesel and petrol engines in Range Rover are coupled with an 8-speed Automatic Transmission. With eight closely spaced ratios, the transmission ensures that you are always in the optimum gear, maximising fuel efficiency and acceleration. Gear changes are almost imperceptible and shift schedules intelligently adapt to your driving style.



MILD HYBRID ELECTRIC VEHICLE

Land Rover is at the forefront of sustainable innovation. Taking our vehicles into a smarter and more exciting future, Mild Hybrid Electric Vehicle (MHEV) technology is a system that uses a belt-driven starter-generator and state-of-the-art 48V battery. These harvest energy that would normally be lost during deceleration, which is then intelligently redeployed.

The stored electricity can be used by the starter-generator to provide torque assistance to the engine directly, or to power the electric Supercharger to boost performance before the conventional Turbocharger reaches its maximum output, giving seamless throttle response. This system helps improve fuel economy and boosts the vehicle's performance. The combination of MHEV technology, together with other detailed efficiency improvements, lower the CO₂ emissions of the Ingenium In-line 6-cylinder engines substantially, when compared to the outgoing engine.

The MHEV technology is standard with the P400 engine. Vehicles with the P400 engine also feature Terrain Response with Dynamic Program as standard.

- 1 48V ELECTRIC SUPERCHARGER
- 2 TWIN-SCROLL TURBOCHARGER
- 3 48V LITHIUM-ION BATTERY
- 4 BELT-DRIVEN INTEGRATED STARTER GENERATOR
- 5 48V/12V DC-DC CONVERTER
- 6 12V BATTERY

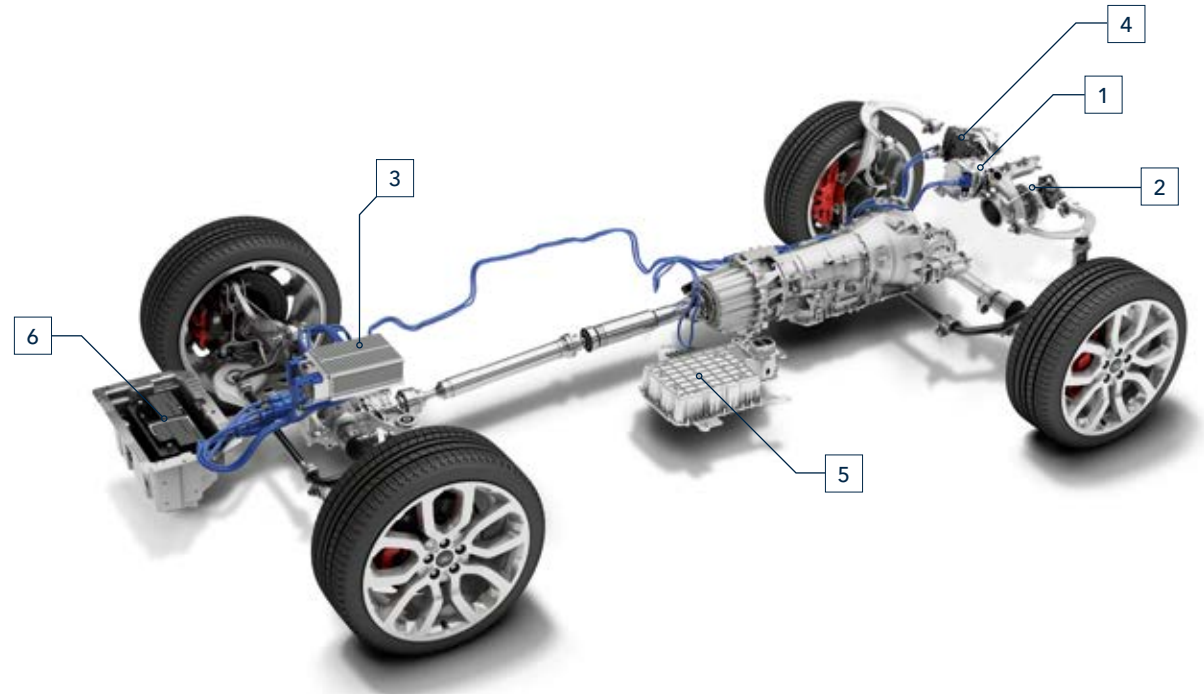



LEGENDARY BREADTH OF CAPABILITY

The Range Rover continues to offer outstanding capability on and off road, with permanent All Wheel Drive (AWD), twin-speed transmission, Adaptive Dynamics and electronic centre differential as standard, whilst Land Rover's revolutionary Terrain Response system means this capability can be harnessed by all drivers, expert and inexperienced alike. This extraordinary capability can be extended to suit individual requirements with a range of additional, optional all-terrain technologies.

ELECTRONIC AIR SUSPENSION

A sure-footed, composed drive is completed by the latest electronic air suspension, which provides exceptional wheel articulation and poise. It changes the vehicle's height quickly, allowing crosslinking of the diagonal wheels to keep all four wheels on the ground on very uneven surfaces. Added to which, it makes loading heavy objects into the boot easier as you can lower the vehicle's rear suspension height by up to 50mm to suit your needs. These functions can be operated via the 10" Touchscreen, a button in the loadspace area or remotely via the key fob.

Range Rover has a choice of ride height settings to assist the driver and passengers of the vehicle at different stages of their journey or across various terrains - from an access height of 50mm below normal ride height, to an extended height of up to 75mm, with a further extended ride height up to an additional 80mm in more extreme off-road conditions.

The Speed Lowering system uses the electronic air suspension to reduce aerodynamic drag and fuel consumption at cruising speeds by lowering the vehicle by 15mm from normal ride height when the speed reaches 65mph.

TWIN-SPEED TRANSFER BOX WITH ELECTRONIC CENTRE DIFFERENTIAL

An additional set of lower gears can prove invaluable in challenging conditions such as steep inclines or declines, off-road driving or when towing. The twin-speed transfer box system gives you precise speed and control in such instances. The heart of the twin-speed system is the electronic centre differential that offers a 50:50 torque split between front and rear axles with the ability to pre-emptively lock the axles before slip commences.



TERRAIN RESPONSE

When you manually select Land Rover's unique standard Terrain Response system, it sets the vehicle up optimally to match the demands of the terrain, by adapting the responses of the vehicle's engine, gearbox, differentials and chassis systems. There are seven manual Terrain Response settings: Comfort, Dynamic, Eco, Grass/Gravel/Snow, Mud and Ruts, Sand and Rock Crawl.

TERRAIN RESPONSE 2

Our unique Terrain Response 2 system is an option designed to monitor driving conditions and automatically optimise driveability and traction by adapting the responses of the vehicle's engine, gearbox, centre differential and chassis systems to match the demands of the terrain. You can manually override the system should you wish.

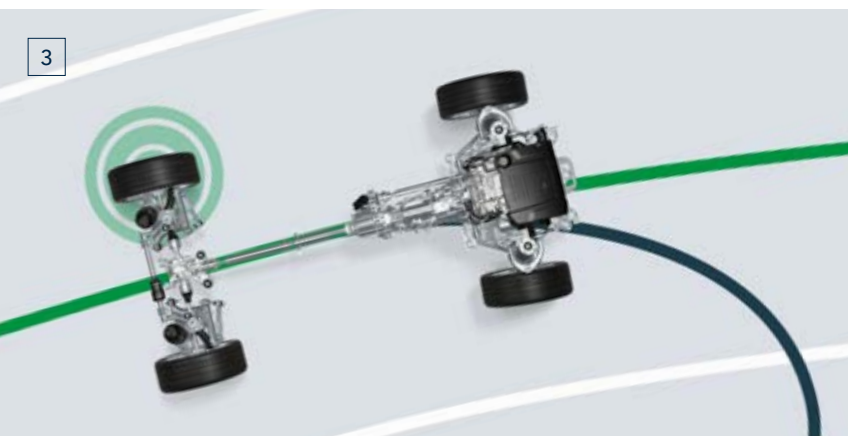
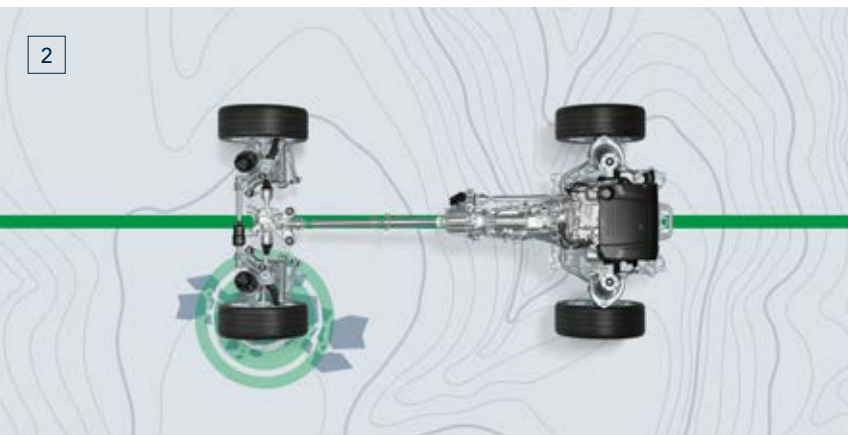

ADAPTIVE DYNAMICS

Adaptive Dynamics makes the miles go by virtually unnoticed. The system monitors vehicle movements up to 500 times a second, reacting to driver or road inputs almost instantaneously to give greater control and minimise body movement, ensuring a composed, flat ride. The system even senses off-road conditions, and optimises damping accordingly so driver and passengers arrive at their destination refreshed and relaxed.

ACTIVE LOCKING REAR DIFFERENTIAL

The Active Locking Rear Differential¹ ensures the greatest level of traction in all weather conditions both on and off-road. Range Rover's permanent All Wheel Drive (AWD) and Electronic Traction Control (ETC), both fitted as standard, distribute torque to both the front and the rear wheels, and brake the wheels independently to improve traction respectively. The addition of the Active Locking Rear Differential delivers the ultimate combination to maximise traction through limiting slip across the rear wheels.

A second multi-plate wet clutch between the rear wheels can lock almost instantly to provide full engine output torque to both wheels. This can be especially useful to deliver effortless capability in low-grip conditions such as patchy ice, wet grass or during wheel articulation off-road. It also provides maximum traction when exiting a corner, as when the inside wheel becomes unloaded due to weight transfer, the Active Locking Rear Differential increases the torque to the outside wheel.

DYNAMIC RESPONSE

Dynamic Response² improves vehicle handling through hydraulic roll control, optimising on-road performance and passenger comfort, by reducing the amount of body lean during cornering. By controlling the front and rear axles independently, it can deliver increased low-speed agility, along with enhanced high-speed stability and greater steering precision.

1 SAFETY

2 ULTIMATE CAPABILITY

3 COMPOSURE

ALL TERRAIN PROGRESS CONTROL

All Terrain Progress Control (ATPC)³ is a state-of-the-art optional system that enables you to set and maintain a steady speed in challenging conditions such as slippery surfaces, including mud, wet grass, ice, snow and dirt roads. Operating like a cruise control system, it functions at low speed between 1mph and 18mph, enabling you to maintain full concentration on steering and finding a path through obstacles.

LOW TRACTION LAUNCH

Providing you with optimum torque control when you move off from a standstill, Low Traction Launch can be activated from the Touchscreen and enhances capability in slippery conditions like wet grass, snow and ice.

HILL DESCENT CONTROL

Land Rover's patented Hill Descent Control (HDC) is a standard feature. It assists the driver with controlled descents of difficult slopes. It does so by maintaining a constant speed and applying braking separately to each wheel.

WADE SENSING

Unique to Land Rover, this optional system uses ultrasonic sensors in the wing mirrors to visually and audibly alert the driver if the water approaches the vehicle's class-leading wading depth of up to 900mm. It does so by providing real-time pictorial information via the Touchscreen about its depth in relation to the vehicle and its maximum wading capability. Only available with 360° Surround Camera.



¹Not available with SDV6, P400 and LWB PHEV engines. ²Only available with V8 engines. ³Not available with PHEV engines. Vehicle shown is Autobiography in Byron Blue with optional features fitted.



INFOTAINMENT

Delivering a wealth of information and entertainment, every Range Rover is equipped with our InControl infotainment system, Touch Pro Duo. It features intuitive and advanced integrated technologies to ensure everyone can make the most of their journey.



TOUCH PRO DUO

The standard 10" dual high-definition Touchscreens allow the user to view required information whilst simultaneously being able to interact with additional features, for increased flexibility and efficiency of use. For instance, you can use the navigation system on the upper screen whilst adjusting multimedia settings on the lower. Direct access to cabin and seat temperature controls are also available via the multi-function Dynamic Dials. For a truly elegant and streamlined appearance, the steering wheel also has hidden-until-lit, touch-sensitive switches as standard. One of these switches is programmable, so that it can be personalised to your preferences to accomplish a host of functions.



INTERACTIVE DRIVER DISPLAY

The 12.3" high-definition Interactive Driver Display can receive and project a vast amount of driving information, entertainment and active safety data including navigation, phone and media. Its high resolution ensures the utmost clarity and its refined processing engine delivers smooth-moving, pin-sharp graphics. Features can be accessed on either the Interactive Driver Display or the Touch Pro Duo Touchscreens.



HEAD-UP DISPLAY

Without distraction or the need for you to take your eyes off the road, Head-up Display is an option that presents key vehicle data such as your speed, gear position and navigation directions on the windscreen. It features crystal clear full-colour graphics in high resolution, enabling you to see all driver inputs and information with ease, including phone/call status. The feature can be turned on and off dependent on driver preference.



REAR SEAT ENTERTAINMENT

The optional Rear Seat Entertainment system provides two 10" high-definition seat mounted articulating Touchscreens. It includes 'Journey Status': a navigation summary screen which displays a pop-up for the rear occupant detailing the time and distance to destination. The system comes with a pair of WhiteFire® digital wireless headphones and HDMI, Mobile High-Definition Link (MHL) and USB connections. Passengers can also enjoy their favourite TV shows via the Digital TV feature.

CONNECTIVITY

InControl is Land Rover's suite of standard and optional features that connects you to your vehicle and links you seamlessly, and securely, with the outside world. With a selection of apps, even when you're away from your vehicle, some of the InControl features stay with you, making sure the Land Rover experience is more enjoyable than ever.

STANDARD FEATURES

VOICE RECOGNITION SYSTEM

So you can complete tasks without taking your eyes off the road, Range Rover offers intelligent voice recognition. For example, 'tune to 97.9' or 'call home'.

PROTECT

Land Rover Optimised Assistance - If you break down you can make a direct call to the Land Rover Assistance team by pressing the button on the overhead console or from the Assistance screen within the Premium smartphone app.

SOS Emergency Call - In a more serious incident, SOS Emergency Call will automatically connect you to the emergency response team who will notify the emergency services to your location.

Journey Tracking - This opt-in feature can automatically record your journey history including your route and mileage statistics. This information can be exported by email to use for expense reporting and can be imported to a spreadsheet.

Vehicle Status Check - Use your smartphone to remotely check current range levels, and status of door and window position and locks. See the last parked location of the vehicle and find your way back to it with on-foot directions.

NAVIGATION PRO

Navigation Pro allows you to save your favourite places, use pinch and zoom gestures for simple map exploration and can display a choice of either 2D or 3D crystal clear map graphics. Navigation Pro functionality is further enhanced by Connect Pro.

CONNECT PRO¹

Connect Pro consists of Remote Premium and Pro Services with 4G Wi-Fi Hotspot, and is designed to enhance your in-car and out-of-car experience, ensuring you and your passengers enjoy the journey whilst remaining connected to the world.

Pro Services include:

- **Real Time Traffic Information** - Uses live traffic data feeds to give you the most accurate picture of what the traffic is like on the way to your destination.
- **Online Search** - Wherever you are, you can search the surrounding area for places of interest. The system can access expert destination information, travel tips and inspiration as well as online travel reviews of the local area.
- **Planning Routes and Door-to-Door Routing** - Before setting off, use the optional Route Planner app or go online to search, save locations or set your destination. The app uses the Cloud to send your destination automatically to your vehicle's navigation screen. Once you've parked, the Route Planner app will guide you to your destination - a true door-to-door experience which includes public transport options.

SECURE TRACKER²

Uses tracking technology to alert you to an attempted theft, and signals your vehicle's location to the relevant authorities, for a timely recovery.

¹Connect Pro requires a SIM with a suitable data contract. Online functionality and Wi-Fi connectivity is dependent on the installation of a micro SIM with a suitable data contract. Land Rover Optimised Assistance and Remote Premium contain subscription services that can be extended after the initial term advised by your Land Rover Retailer. InControl features, options and their availability remain market dependent - check with your Land Rover Retailer for local market availability and full terms. Information and images displayed in relation to the InControl technology, including screens or sequences, are subject to software updates, version control and other system/visual changes depending on options selected. Mobile network connectivity cannot be guaranteed in all locations. Remote App will need to be downloaded from the Apple/Play Store. All in-car features should be used by drivers only when safe for them to do so. Drivers must ensure they are in full control of the vehicle at all times. ²Secure Tracker will require further subscription after the initial term as advised by your Land Rover Retailer.

Stay connected while on the move. When specified with 'Pro Services and Wi-Fi Hotspot', your new Range Rover will arrive with a SIM card equipped with an essential data plan of 500MB of data per month for the initial warranty period. You'll be better connected, receiving live traffic updates and more. Additional data can be purchased. Terms, conditions and restrictions apply. Contact your local Jaguar Land Rover Retailer for more information.

- **Share ETA** - You can share your estimated time of arrival so your selected contact(s) will know exactly when you will arrive, as calculated by the navigation guidance system. If you're running late, Share ETA can then send automatic updates via text messages or email, without any further action from you.
- **Satellite View** - When you want to get the context of your surroundings from overhead, simply switch to satellite view.
- **Fuel Prices** - When you're going to fill up, the Fuel Price service not only finds filling stations along your route, it also enables you to compare fuel prices so you can keep your costs down³.
- **Commute Mode** - Allows the system to learn your commutes and automatically advises you of the expected journey time based on live and historical traffic movements without you having to input a destination. The system learns the routes you take for a given destination and then advises which of those is the quickest. The feature can be turned on and off dependent on driver preference.
- **Parking Service** - As you approach your destination, you can see where parking is available. Simply tap on your preferred car park and the navigation system updates to direct you to it.
- **Online Routing** - While you're on your way to a destination the system monitors live traffic conditions and takes into account typical traffic patterns for that time of day, keeping you on the optimum route.
- **Safety Cameras** - Alerts you to the location of accident black spots monitored by safety cameras.
- **Online Media** - Allows for the aggregation of numerous content providers and their personalised content - such as Deezer and Tuneln - that gives access to more than 40 million music tracks and four million on-demand programmes and podcasts. For the first time, these can be directly streamed from the vehicle without the need for a smartphone - providing a seamless and integrated experience.



³Fuel prices are only available for participating fuel stations only.

REMOTE PREMIUM¹

Remote Premium provides information on your vehicle and enables you to interact with it remotely. Compatible with most smartphones, Android Wear™ or Apple Watch®, this service includes:

- **Remote Lock/Unlock** - Lock or unlock your doors remotely with the click of a button. Simply press the 'lock' button on the Vehicle Security screen of the Remote Premium smartphone app to single lock the doors, arm the alarm, fold in the wing mirrors and close the windows. Press the 'unlock' button to unfold the wing mirrors, turn on the dipped headlights and cause the hazard lights to flash twice.
- **Remote Climate** - Prepare your Land Rover in advance by pre-heating or pre-cooling the cabin, so that you and your passengers are comfortable from the moment you step inside.
- **Beep/Flash** - This feature turns on your Land Rover's hazard lights and dipped headlights, and sounds an audible alert to help you locate your vehicle in a crowded car park.

REMOTE PREMIUM - PHEV ENHANCEMENTS

- **Charging Status Information** - Stay continually updated with key battery function indicators including charge state, charging status, charge rate, plug state and estimated EV range.
- **Remote Control Actions** - Use your smartphone to remotely start and stop charging, manage charging tariffs and even set the maximum state of charge.

SMARTPHONE PACK

By screen sharing with Range Rover's InControl infotainment system, the Smartphone Pack helps you stay safely connected to your smartphone even while in the car.

Applications include:

- **Android Auto™** - was designed with safety in mind. With a simple and intuitive interface, it is designed to minimise distraction so that you can stay focused on the road. Simply connect your Android smartphone via a USB and control compatible apps on the in-car Touchscreen.
- **Apple CarPlay®** - is also designed for increased safety, enabling the use of apps while allowing the driver to concentrate on the road ahead. Connect your Apple smartphone to your car to use compatible apps such as maps, messages and music through the Touchscreen.

¹Remote Premium contains subscription services that can be extended after the initial term advised by your Land Rover Retailer. InControl features, options and their availability remain market dependent - check with your Land Rover Retailer for local market availability and full terms. ²Secure Tracker Pro will require further subscription after the initial term as advised by your Land Rover Retailer.

Information and images displayed in relation to the InControl technology, including screens or sequences, are subject to software updates, version control and other system/visual changes depending on options selected. Mobile network connectivity cannot be guaranteed in all locations. Remote App will need to be downloaded from the Apple/Play Store. All in-car features should be used by drivers only when safe for them to do so. Drivers must ensure they are in full control of the vehicle at all times.

The Bluetooth word mark and logos are owned by the Bluetooth SIG, Inc. and any use of such marks by Land Rover is under licence. iPhone® is a registered trademark of Apple Inc., registered in the US and other countries. Please ensure iPhone compatibility is reviewed with your local Land Rover Retailer.

Android™ is a trademark of Google Inc. Apple Watch® and Apple Carplay® are registered trademarks of Apple Inc., registered in the US and other countries.

OPTIONAL FEATURES

SECURE TRACKER PRO²

Integrates authentication technology into the key fob. An alert will be sent within minutes to the Stolen Vehicle Tracking Centre if your car is stolen with non-authorized or cloned keys. Includes service subscription for warranty period.



AUDIO

A vehicle's cabin is the ideal place within which to experience your personal choice of music and Range Rover has the option of three different audio systems to bring your music to life:

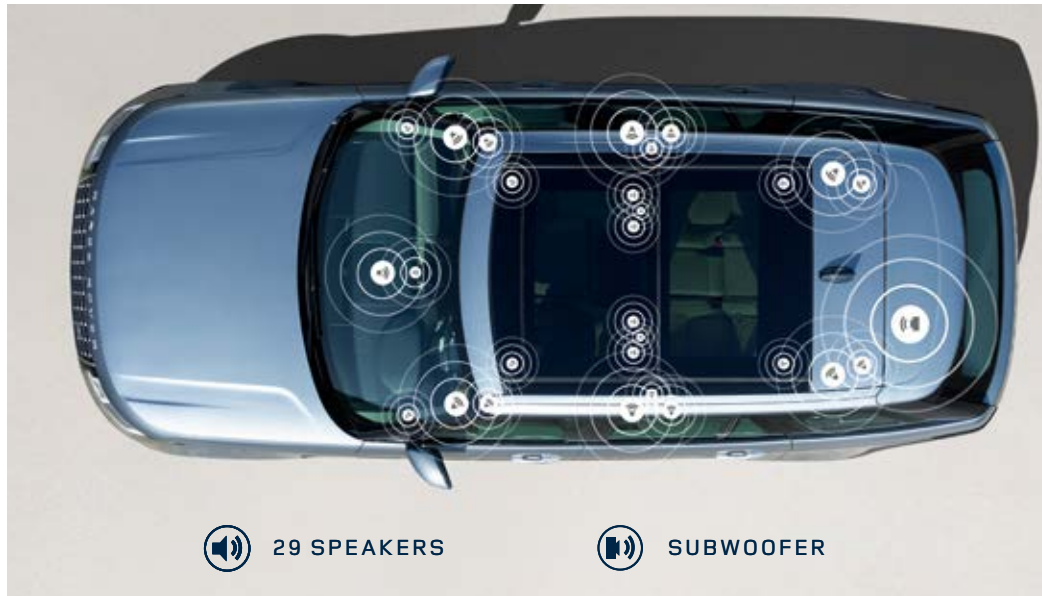

MERIDIAN™ SOUND SYSTEM

Great definition, crystal clear highs and full, deep bass - delivered through the careful arrangement of 13 speakers including a dual channel subwoofer.

MERIDIAN SURROUND SOUND SYSTEM

All the fullness and clarity of a live performance delivered through an arrangement of 19 speakers including a dual channel subwoofer - seamlessly brought together using Trifield™ technology. Exclusive to Meridian, Trifield perfectly blends the centre and surround channels with left and right channels ensuring an optimum, consistent sound experience for each passenger.

MERIDIAN SIGNATURE SOUND SYSTEM

This delivers truly life-like reproduction, creating a profound, personal sound experience for every seat. World-first Trifield 3D technology takes surround sound to the next level, as the Signature Sound System includes 29 speakers including a dual channel subwoofer. Incredibly authentic, the sense of cabin space is expanded to a 3D experience - rendering all the instruments, performers and venues of your favourite performances in true scale and location.

DAB RADIO

The standard DAB radio technology offers improved sound quality, a wide choice of stations and live text information about the station, show and song you are listening to.

MODEL AVAILABILITY	VOGUE	VOGUE SE	AUTOBIOGRAPHY	SVAUTOBIOGRAPHY DYNAMIC	SVAUTOBIOGRAPHY LONG WHEELBASE
Meridian™ Sound System	■	-	-	-	-
Meridian™ Surround Sound System	□*	■	■	-	-
Meridian™ Signature Sound System	-	□	□	■	■

■ Standard □ Optional - Not Available.

*Meridian™ Surround Sound System is standard on Vogue PHEV.

MERIDIAN™

Formed in 1977 in Cambridgeshire, England, Land Rover’s audio partner Meridian has pioneered many firsts including active speakers and the world’s first digital surround sound processor.

Meridian’s audio technology input has helped ensure that Range Rover is the most superb space within which to experience sound. Meridian Cabin Correction technology was utilised to analyse cabin shape, acoustics and resonance characteristics in order to help remove unwanted sounds.

The advanced algorithm ensures that the rhythm, punch and timing of any piece of music are heard precisely how the artist intended, providing a consistently exceptional quality audio experience for all passengers in the vehicle.



DIGITAL SIGNAL PROCESSING

Brings all elements of the audio system together as one, for performance that would otherwise require significantly larger speakers.



MERIDIAN CABIN CORRECTION

The advanced algorithm of Meridian’s Cabin Correction tailors the sound experience to the precise acoustics of Range Rover’s interior.



MERIDIAN DIGITAL DITHER SHAPING

To maintain the quality of musical recordings, they are converted into a common digital format. Meridian Digital Dither Shaping ensures that digital signal conversions are made smoothly and seamlessly, preserving the finest details of the audio performance. The result is authentic musical conversion, evoking the emotions of the original recording.













TRIFIELD™

Exclusive to Meridian, Trifield blends the centre and surround channels seamlessly with left and right channels, delivering a consistent, concert-like experience for all occupants.



TRIFIELD 3D

Building on Meridian’s proven Trifield surround sound technology – world-first in-car Trifield 3D truly brings musical performances to life. Through the addition of dedicated height channels, the sense of cabin space is expanded to a 3D experience, for a supreme sense of scale and definition to your music.

	UNIQUE MERIDIAN TECHNOLOGY	SPEAKERS	WATTS
MERIDIAN™ SOUND	  	13	380
MERIDIAN™ SURROUND SOUND	   	19	825
MERIDIAN™ SIGNATURE SOUND	   	29	1700

DRIVER ASSISTANCE

MAKING DRIVING EASIER

From negotiating city traffic or the motorway, to providing additional safety for you and your passengers, there's a wealth of innovative technologies available; either as standard, optional or as part of an optional pack. Whichever you choose, you'll find every single feature has been designed and engineered to heighten your enjoyment of the vehicle.

STANDARD DRIVE FEATURES



Lane Departure Warning

- **Cruise Control and Speed Limiter** allows the driver to maintain the current speed of the vehicle without the need for continued use of the accelerator pedal, helping to reduce driver fatigue. The Speed Limiter will also allow the driver to pre-set a maximum specified speed which the vehicle will not exceed. Both functions can be easily turned on or off by the driver as desired.
- **Emergency Braking** can help to prevent collisions with other vehicles or pedestrians. If a potential frontal collision is detected, a warning is displayed, giving you time to take action. A camera at the front of the vehicle monitors at speeds from 3 to 50mph for frontal collisions and 3 to 37mph for pedestrians. If a collision is still anticipated and you have taken no action, this system will apply the brakes to help reduce the severity of the possible impact.
- **Lane Departure Warning** can help make long journeys much safer. The system senses when your vehicle is unintentionally drifting out of your lane, and notifies you with a visual alert and a gentle vibration of the steering wheel.

OPTIONAL DRIVE FEATURES



Adaptive Cruise Control

- **Adaptive Cruise Control** will keep your vehicle a safe distance from the one in front, should it slow or stop when you're cruising on the motorway or travelling in slow-moving traffic. Should the vehicle in front stop completely, your vehicle will come to a smooth halt. In stop-start traffic, Adaptive Cruise Control will automatically resume following the car in front. The system can be activated from 9mph and once activated will operate between 0-124mph.
- **High-speed Emergency Braking** detects when a potential frontal collision with another vehicle may occur and displays a forward alert to warn the driver to brake. If the driver doesn't react, the vehicle will deploy the brakes in order to reduce the severity of the possible impact. High-speed Emergency Braking is ready and active from 6mph to 99mph.

All in-car features should be used by drivers only when safe for them to do so. Drivers must ensure they are in full control of the vehicle at all times.

OPTIONAL DRIVE PACKS

DRIVE PACK



Traffic Sign Recognition with Adaptive Speed Limiter

The optional Drive Pack offers a range of features that help keep you safe and informed. The Drive Pack includes:

- **Driver Condition Monitor** detects if you're starting to feel drowsy and gives you an early warning when you need to take a break.
- **Blind Spot Monitor** alerts you to vehicles in, or quickly approaching your blind spot. When a vehicle is detected, a small warning light will illuminate in the corresponding wing mirror. If you indicate in the direction of the obstacle, the warning light will flash to highlight potential danger.
- **Traffic Sign Recognition** keeps you informed and aware on the road, by displaying speed limits and 'no overtaking' signs in the instrument cluster, where they can easily be seen. When activated, Adaptive Speed Limiter uses Traffic Sign Recognition information to adjust your vehicle's speed accordingly.
- **Adaptive Speed Limiter** uses data from the Traffic Sign Recognition system to automatically select speed limit. If the system detects the vehicle is above the speed limit, such as when entering a lower limit, the accelerator will be disabled allowing the vehicle to coast down to the limit. The driver can also apply the brakes to achieve this more quickly.

DRIVE PRO PACK



Blind Spot Assist

For an even more relaxed drive, the optional Drive Pro Pack contains a wide range of driver assistance features including the Driver Condition Monitor and Traffic Sign Recognition with Adaptive Speed Limiter in the Drive Pack, plus:

- **Lane Keep Assist** detects when your vehicle is unintentionally drifting out of your lane, and applies a corrective torque to the steering wheel, encouraging you to guide your vehicle back.
- **Blind Spot Assist** can help prevent collisions. If your vehicle detects another car in your blind spot when you begin to change lanes, a small warning light illuminates in the corresponding wing mirror and a corrective steering torque encourages you to guide your vehicle away from the approaching vehicle.
- **Adaptive Cruise Control** - See page 36 for description.
- **High-speed Emergency Braking** - See page 36 for description.

ENJOY STRESS-FREE PARKING

Range Rover offers the most advanced technologies to deliver intuitive and easy parking solutions. Whether reversing, parallel parking or getting into or out of tight spaces, these features make life easier. Available as standard, optional or as part of an option pack.

STANDARD PARK FEATURES



Front and Rear Parking Aid

- **Front and Rear Parking Aid** helps make manoeuvring even easier. When you select Reverse, or choose to activate them manually, sensors located in the front and rear bumpers are triggered. As you park, the Touchscreen display and audio feedback indicate how close you are to obstacles.
- **Rear Camera** provides improved visibility when reversing. Static lines representing the vehicle's outer perimeter and predicted path are superimposed on the rearward image, to make parking in tight spots as easy as possible. This valuable parking aid also helps when hitching a trailer.

OPTIONAL PARK FEATURES



360° Surround Camera

- **360° Surround Camera** uses four digital cameras discretely placed around the vehicle, providing a 360° overhead view on the Touchscreen. With the capacity to display several different views at the same time, this helps with various manoeuvres from parking by a kerb, to getting in and out of tight spaces and junctions.

OPTIONAL PARK PACKS

PARK PACK



360° Parking Aid

The optional Park Pack assists you with manoeuvring in tight spaces and in urban environments, it features:

- **360° Parking Aid** gives you complete confidence when manoeuvring in tight spaces. Sensors located around the vehicle are automatically triggered when Reverse is selected, or can be manually activated, with a graphic appearing on the Touchscreen showing an overhead view of the vehicle. As you park, the Touchscreen display and audio feedback indicate how close you are to obstacles.
- **Rear Traffic Monitor** is particularly useful when reversing out of a parking bay. The system warns you of vehicles, pedestrians or other hazards approaching from either side of your vehicle. It will alert you with both audio and visual warnings so you know what's behind you even when the view is obstructed.
- **Clear Exit Monitor** alerts rear passengers to any approaching cars, cyclists or other hazards before they leave the vehicle. As the rear seat passenger pulls the door handle to leave your vehicle, a warning light will flash on the rear door if an incoming obstacle is detected.

PARK PRO PACK



Park Assist

The optional Park Pro Pack enables you to park and manoeuvre safely and securely in and out of tight spaces and into traffic that is obscured by buildings or other vehicles. It includes the 360° Parking Aid, Rear Traffic Monitor and Clear Exit Monitor in the Park Pack, plus:

- **Park Assist** makes parallel and perpendicular parking easier than ever by steering your vehicle into a suitable space. You just have to select the appropriate gear and control the vehicle's speed with the brake and accelerator pedals. Graphics and notifications guide you through the manoeuvres. Park Assist will also steer you out of a space, taking all of the stress out of parking.

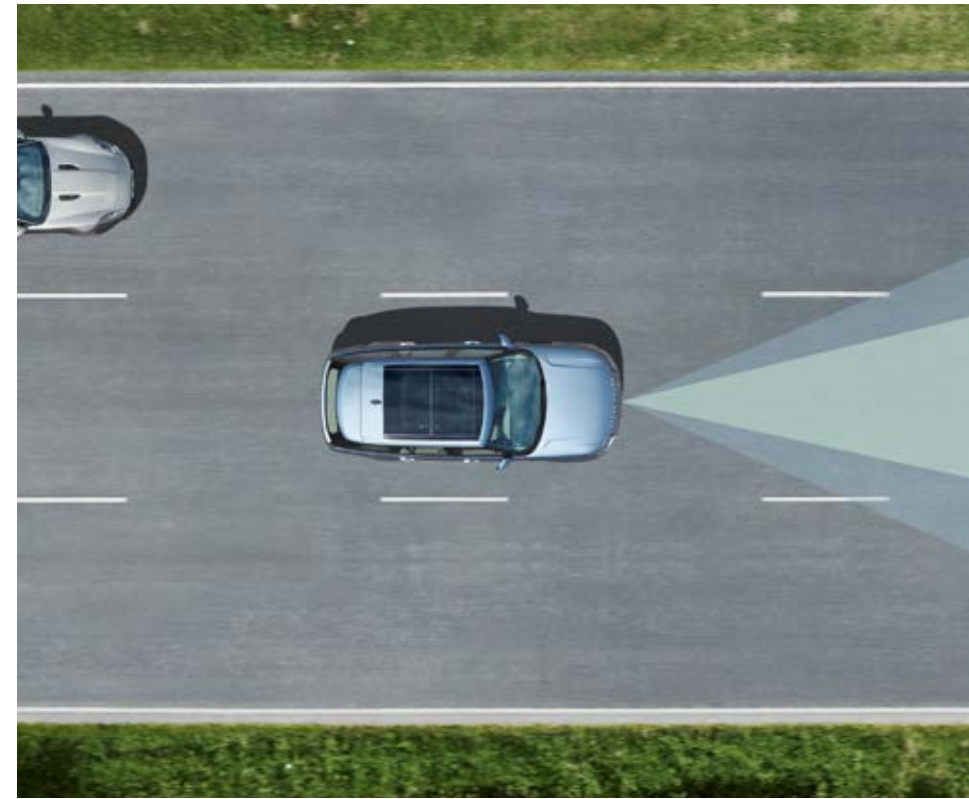

DRIVER ASSIST PACK

The optional Driver Assist Pack offers a wide range of driver aids including the features found in the Drive Pro Pack (see page 37), the Park Pro Pack (see page 39) and the 360° Surround Camera. It also includes Adaptive Cruise Control with Steering Assist. Moderate steering interventions ensure that the physical effort of maintaining a central vehicle position is reduced.

FRONT CAMERA

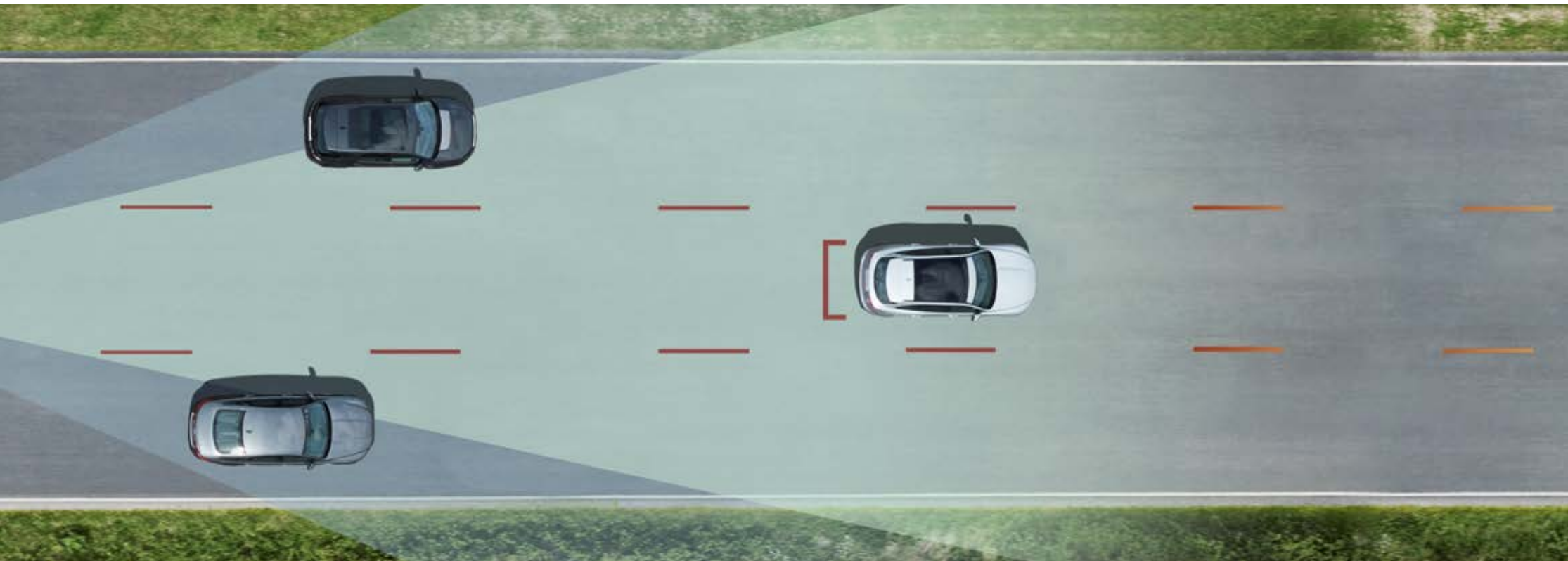

FRONT RADAR



ADAPTIVE CRUISE CONTROL WITH STEERING ASSIST

Adaptive Cruise Control with Steering Assist can be activated from 9mph and once activated will operate between 0-112mph. It begins functioning when you depress the 'Set' cruise button. A camera and radar then work together to track lanes ahead to maintain a central position for your vehicle, and moderate its speed according to the behaviour of the traffic ahead of you. If the vehicle ahead slows, even to a standstill, the feature automatically slows your vehicle, bringing it to a stop where necessary, to maintain a relaxed and composed drive in busy traffic situations.

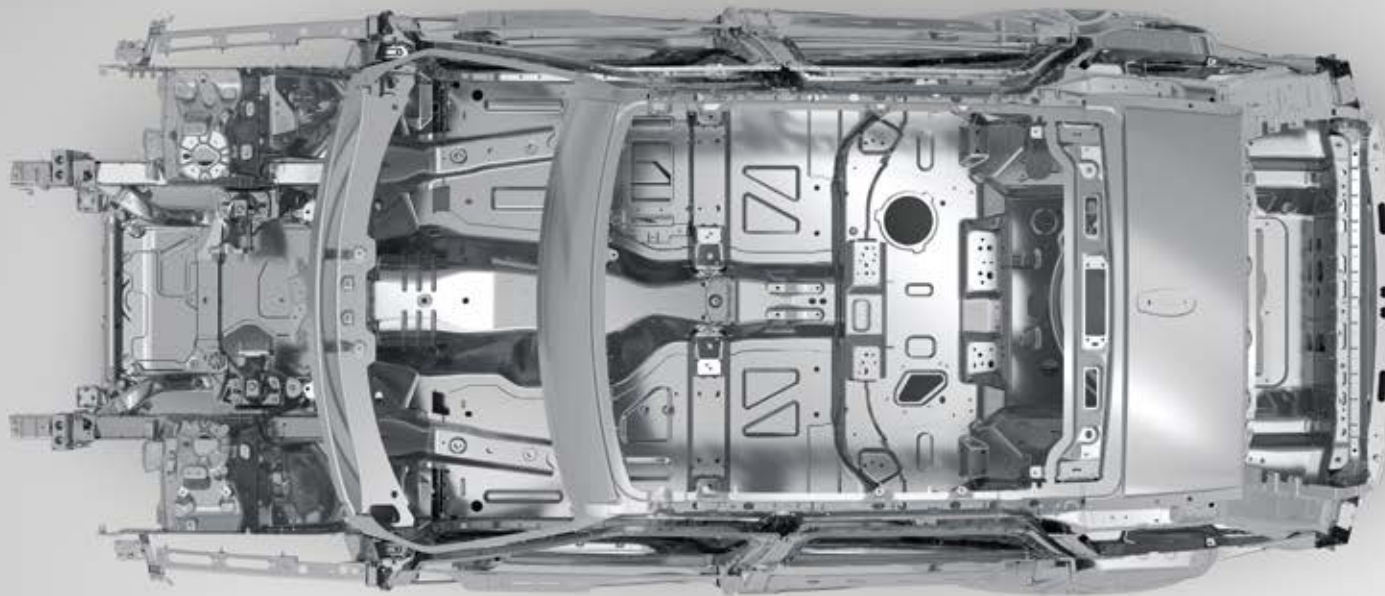
Adaptive Cruise Control with Steering Assist works with you; as you keep your hands on the wheel anticipating the road ahead, the system assists with steering, braking and acceleration. Should you remove your hands from the wheel, the vehicle will provide a warning. If the warning is not heeded then the Steering Assist is deactivated but the Adaptive Cruise Control remains active.



EFFICIENT TECHNOLOGIES

SUSTAINABLE BY DESIGN

Land Rover are committed to producing vehicles that use more sustainable materials, produce less waste and use fewer natural resources as part of our approach to sustainable business. Range Rover's development process has included a full life cycle assessment and has been designed to be 85 percent recyclable/re-usable and 95 percent recoverable at the end of the vehicle's life.

Our innovative design enables the use of a unique alloy in the vehicle body, made from up to 50 percent recycled aluminium derived from our closed loop manufacturing process, retaining quality and performance but delivering lower life cycle CO₂ emissions. Closed loop manufacturing means taking the scrap from the body pressings process, segregating it and re-melting it back into quality sheet aluminium at our supplier, to be used again to press out body panels, thereby reducing the need to use primary aluminium.

ENGINE MANUFACTURING CENTRE

Jaguar Land Rover's Engine Manufacturing Centre, where our Ingenium engines are assembled, has been built to the highest environmental standard (BREEAM Excellent) and features one of the largest rooftop solar panel installations in the UK. Comprising no fewer than 22,600 individual panels with 6.2MW generating capacity, the panels have the capability to provide up to 30 percent of the site's energy needs.

SMART REGENERATIVE CHARGING

Smart regenerative charging prioritises the charging of the battery when the vehicle is decelerating to capture wasted kinetic energy and reduce fuel consumption. Not available on P400e.

LOW CO₂ TECHNOLOGIES

Range Rover powertrains incorporate a variety of low CO₂ technologies. Our intelligent Stop/Start system is designed to improve fuel efficiency and reduce emissions. Mild Hybrid Electric Vehicle (MHEV) - considered the next generation of Stop/Start technology - takes this even further. Our latest Plug-in Hybrid Electric Vehicle (PHEV) ensures both optimum performance and efficiency.



Please refer to the accompanying Technical Specification for full details on driveline, engine performance and fuel economy. Note that CO₂ and fuel economy figures can vary according to wheel fitment, and the lowest figures may not be achievable with the standard wheels.

SAFETY

SAFE AND SECURE

With its sophisticated design cues and use of materials, Range Rover provides a high degree of protection. Its all-aluminium monocoque body makes it one of the strongest vehicles of its kind. The inclusion of high strength aluminium in the body structure ensures minimum intrusion into the safety cell in the event of a collision, while the elevated Command Driving Position provides enhanced visibility in all conditions. You can see more of the road and be easily seen by other road users, providing an enhanced feeling of safety and confidence.

It has also been engineered to include a wealth of standard features not only to protect you and your passengers, but to actively help prevent accidents occurring:

Dynamic Stability Control (DSC) monitors Range Rover's dynamic behaviour, intervening to maximise vehicle stability. DSC reduces engine torque and applies braking to the appropriate wheels to correct the vehicle's direction of travel by counteracting understeer or oversteer.

Anti-lock Braking System (ABS) allows the vehicle to maintain traction with the road surface whilst braking and prevents wheels from locking - thereby retaining the vehicle's ability to steer. The system helps to shorten the braking distance.

Electronic Brake-force Distribution (EBD) automatically varies the braking force to each axle in order to minimise stopping distance, while still maintaining stability and the vehicle's ability to steer.



Electronic Traction Control (ETC) optimises traction and stability by controlling wheel spin. The ETC system reduces torque to the spinning wheel, then applies braking to the wheel, if required.

Cornering Brake Control (CBC) automatically varies the braking force to each wheel when the vehicle's brakes are applied around a corner and the limit of grip is reached. The system will prevent the vehicle's wheels from locking up and skidding in this event through varying the braking force applied to each wheel.

Roll Stability Control (RSC) is integrated with DSC to reduce the possibility of rollover, while providing agility and ability to steer around obstacles. It monitors the vehicle motion and cornering forces to detect any potential risk of rollover. When risk is detected, braking is applied to the outside front wheel to reduce forces which contribute to rollover.

Emergency Brake Assist understands when you apply the brakes quickly but without the necessary force to maximise stopping performance. It therefore boosts the brake pressure through the ABS pump to ensure you stop in time.

Hazard Lights Under Braking - To help reduce the risk of a collision, the Emergency Stop Signal system automatically activates the hazard warning lights during emergency braking.

To improve safety further for all the family, two ISOFIX points for baby/child seat restraints are fitted on each side of the rear seats and additional protection is offered by seat belt pretensioners which, in the event of a front impact, reduce forward movement. To further protect you, there is a comprehensive system of airbags including driver and passenger airbags, side curtain and thorax.

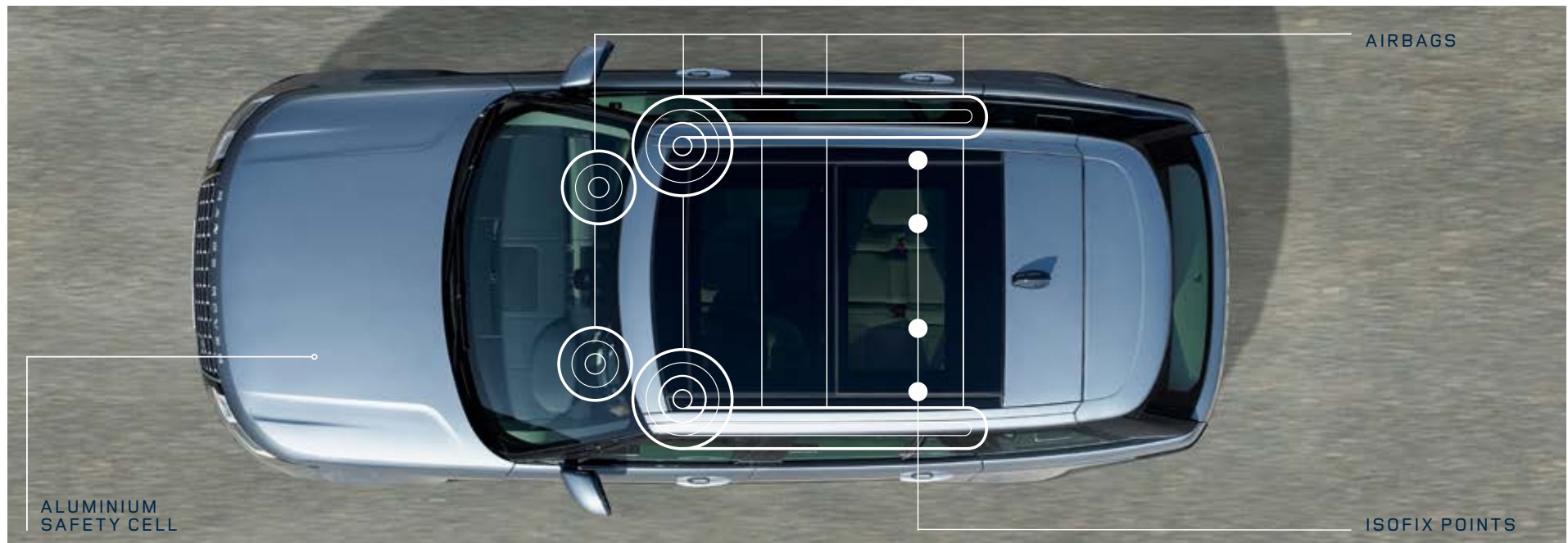



LIGHTING TECHNOLOGY

Range Rover features all-round exterior LED lighting with standard features including signature Daytime Running Lights, automatic headlights and power wash. LED lights are designed to last the lifetime of the vehicle and are more energy efficient. Also, the quality of light produced is closer to daylight conditions, so driving at night becomes less tiring.

A range of beam pattern assistance features provide maximum light while minimising the impact on other road users.

Matrix LED headlights and **Pixel LED headlights** both feature an Adaptive Front-lighting System (AFS) and also enable Advanced Driving Beam (ADB). The AFS optimises the lighting beam to suit a range of driving conditions: town, country, motorway and bad weather, while the ADB allows you to use both the high and low beam concurrently. By splitting the main beam into vertical strips, the Matrix LED headlights can cast up to four vertical shadows in front of vehicles ahead to help to prevent dazzling without having to dip the main beam and lose the illumination.

Optional Pixel LED headlights, with nearly three times as many LEDs than the Matrix headlights, offer our most advanced headlight technology and build on the ADB capability to ensure maximum light. By splitting the main beam pattern vertically and horizontally, they enable up to four higher definition shadows to help to avoid dazzling multiple vehicles ahead. This headlight option incorporates Bending Lights, which operate at higher speeds to direct the main beam pattern according to the direction of steering.

Optional Pixel-laser LED headlights build on the Pixel LED headlight option with the addition of laser technology. The long-range laser high beam delivers five times higher luminance than standard LED lights and is particularly useful for long, straight road driving. They become operational above 50mph and when no other external lights detected, to produce clear sight for up to 550m.



HEADLIGHT FEATURES	MATRIX LED HEADLIGHTS	PIXEL LED HEADLIGHTS	PIXEL-LASER LED HEADLIGHTS
Number of LEDs per vehicle	52	142	144
Adaptive Front Lighting (AFS)	■	■	■
Matrix Advanced Driving Beam (ADB)	■	-	-
Pixel Advanced Driving Beam (ADB)	-	■	■
Dynamic Bending Light	-	■	■
Laser High Beam	-	-	■
Sign Post Dimming	■	■	■
Tourist Mode	-	■	■

■ Standard - Not Available.



AUTOMATIC ACCESS HEIGHT 50MM



VERSATILITY

TRULY FLEXIBLE

ELEGANT ARRIVAL

There's a raft of features to make every journey even more comfortable and enjoyable than ever. **Automatic Access Height** allows you to get in and out of the vehicle with greater ease and elegance as, when activated, this feature lowers the vehicle by as much as 50mm. Prior to leaving the vehicle, **Clear Exit Monitor¹** provides an alert to rear seat passengers to prevent them opening the door onto approaching obstacles. The vehicle is also available with optional soft door close to provide power latching on the front and rear doors.

INTERIOR CLIMATE

To prevent the cabin from overheating in the sun and minimise demands on the air conditioning, the **auto sunblind²** closes automatically when passengers have disembarked and the doors locked. When the vehicle is re-opened the sunblind returns to the position prior to it auto-closing. The optional **Cabin Air Ionisation** with Nanoe™ technology improves the air quality within the vehicle's cabin, and reduces allergens, viruses, airborne bacteria and associated odours. It does so by ionising particles in the air, making them attract to surfaces and thus helping to cleanse the air. And optional **Four-zone Climate Control** can also make life more comfortable by adjusting temperature levels, direction and intensity of airflow.

¹Optional on Vogue, standard on all other derivatives. ²Only available with a panoramic roof. Nanoe™ is a trademark of Panasonic Corporation.

Vehicle shown is Autobiography in Byron Blue with optional features fitted.

ACTIVITY KEY

With the optional **Activity Key** you can enjoy your favourite activities and keep your vehicle key securely in the vehicle. For extra convenience, you can strap the Activity Key to your wrist. The wristband is robust and fully waterproof, allowing you to take part in a range of activities from horse riding to swimming. Simply touch your Activity Key on the tailgate (behind the letter R in the Range Rover script) to lock or unlock the car and deactivate or reactivate the conventional key fob.

TAILGATE

The split tailgate is distinctly Range Rover. Its electrically operated upper and lower tailgates help provide a platform for social and sporting events, coupled with greater protection from the elements. **Powered gesture tailgate** allows you to open and close the tailgate from the kerb without needing to touch either the vehicle or the key fob. And as the system is compatible with optional towing solutions, you can still tackle demanding situations with the least amount of fuss. Access to the loadspace is enhanced with **Rear Height Adjust** which lowers the rear suspension by up to 50mm when the tailgate is opened. This creates a more natural ramp angle for ease of loading.





BENCH SEATING



5 SEATS

DRY 707/707 LITRES (SWB/LWB)	WET 900/900 LITRES (SWB/LWB)
---------------------------------------	---------------------------------------



4 SEATS

DRY 1,102/1,156 LITRES (SWB/LWB)	WET 1,317/1,397 LITRES (SWB/LWB)
---	---



3 SEATS

DRY 1,299/1,389 LITRES (SWB/LWB)	WET 1,526/1,645 LITRES (SWB/LWB)
---	---



2 SEATS

DRY 1,694/1,856 LITRES (SWB/LWB)	WET 1,943/2,142 LITRES (SWB/LWB)
---	---

INTELLIGENT SEAT CARGO MODE/CONVENIENCE FOLD

Intelligent Seat Cargo Mode - enabling the power fold of the rear seats, whilst moving the front seats forward and preventing obstruction - is fitted with all 60:40 bench seats with power recline and load-through (ideal for long items such as skis). **Convenience Fold**, available with the optional rear Executive Class seats only, allows you to configure the rear seats via the upper Touchscreen or an app on your smartphone, which can be truly useful when you're returning with a clutch of shopping bags or an awkward load.

REAR EXECUTIVE CLASS SEATING



POWER AND STOWAGE

With optional 2 x domestic power sockets, up to 5 x 12V sockets and up to 7 x USB ports located throughout the cabin, multiple electronic devices can be charged on the go. And to ensure your cabin is clutter-free, there is increased stowage space including a recess specifically for smartphones in the front centre console compartment. In addition to the optional front centre cooler compartment, a front centre refrigerator compartment can be specified as an alternative, to provide the luxury of cooling drinks on demand. It can accommodate up to 4 x 500ml bottles and maintain them at a temperature of 5°C, with the ability to perform a rapid cool to quickly chill your drink.



TOWING

With a towing capacity of up to 3,500kg¹ and by incorporating tailored technologies, Range Rover can handle the most demanding of tasks.

ELECTRICALLY DEPLOYABLE TOW BAR²

This optional system is deployed using a convenient button in the loadspace compartment, or via the Touchscreen.

TOW HITCH ASSIST

Tow Hitch Assist makes coupling a trailer to the vehicle much easier by helping you visualise the hitching process; it displays the predicted path of the vehicle tow ball towards the trailer tow bar on the Touchscreen.

REAR HEIGHT ADJUST

Rear Height Adjust allows the use of switches in the loadspace or on the key fob to lower the rear suspension height by up to 50mm - useful when loading or unloading cumbersome items, or when hitching, unhitching or loading a trailer.

TOW ASSIST

Tow Assist helps with reversing by predicting the trailer's direction. The system displays the predicted path of both the vehicle and the trailer as coloured trajectory lines on the Touchscreen. For precise guidelines you can even choose your trailer's width. Standard with 360° Surround Camera.

ADVANCED TOW ASSIST

Advanced Tow Assist allows you to control the direction of your trailer when reversing by using the rotary Terrain Response 2 controller. The optional system will control the vehicle's steering to achieve the desired trailer trajectory.

TRAILER STABILITY ASSIST

Trailer Stability Assist (TSA) gives you greater stability when towing. Should TSA detect a dangerous trailer sway situation is developing, it can help you regain control by gradually reducing Range Rover's speed through lowering engine power and applying the brakes individually on each side of the vehicle to control the sway.



¹2,500kg limit on P400e, 3,400kg on SDV8 Long Wheelbase models. ²Not available on P400e. Vehicle shown is Autobiography in Byron Blue with optional features fitted.







SPECIAL VEHICLE OPERATIONS

SVAUTOBIOGRAPHY DYNAMIC

EXTERIOR

Designed and engineered by Special Vehicle Operations (SVO) – Land Rover’s centre of excellence for bespoke commissions, luxury editions and performance models – the SVAutobiography Dynamic offers the pinnacle in performance and luxury.

Designed for luxury performance, the flowing lines and contemporary design of SVAutobiography Dynamic will turn heads all over the world. With a tuned chassis, steering, exhaust and suspension, the SVAutobiography Dynamic sits 8mm lower than a standard Range Rover – its aggressive stance hinting at the power and performance contained within. Unique Graphite Atlas accents, distinctive Red Land Rover branded brake calipers and exclusive wheels add to the performance appeal of the vehicle. The SVAutobiography Dynamic provides a new level of agility and performance for the driver to enjoy.

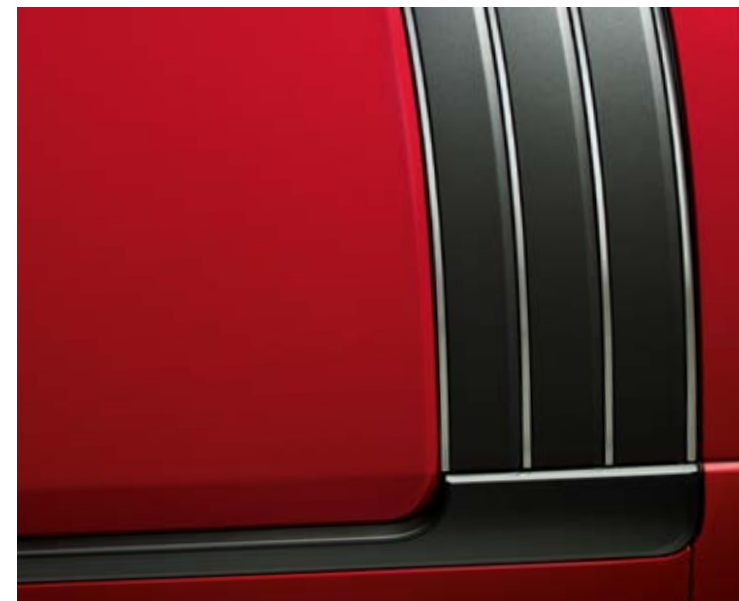

INTERIOR

Encapsulating luxurious comfort and style, the interior of SVAutobiography Dynamic epitomises the very best in sublime craftsmanship. Alluring to the touch, only the very finest Diamond Quilted leathers feature within the cabin. A knurled finish to interior features, including the Stop/Start button and foot pedals, adds to the sense of refinement. The rotary shifter and Steel Weave Carbon Fibre finishers reflect SVAutobiography Dynamic's distinctive personality.



Actual seats have new cushions and interlayers with softer, looser leather to optimise these features. Please refer to your Land Rover Retailer for more information.

Interior shown is SVAutobiography Dynamic in Ebony/Vintage Tan with Ebony/Vintage Tan seats and Steel Weave Carbon Fibre veneer with optional features fitted.



SVAUTOBIOGRAPHY LONG WHEELBASE

EXTERIOR

Craftsmanship never goes out of style and over 45 years of expertise in designing Range Rover is manifested in each SVAutobiography Long Wheelbase. Every tailored aspect whispers elegance and attention to detail. Approaching the front, each vehicle is crafted with luxury design cues such as the unique front grille¹ and 'Range Rover' front and rear script with a dark knurled-effect finish, edged in Bright Chrome.

The SVAutobiography Long Wheelbase retains a poised stance, even with the 200mm extra length. Body-coloured side vent graphics are punctuated by Bright Chrome inserts, with Bright Chrome door handle surrounds and tailgate finisher. Unique 21" and 22" wheel choices complete the luxury design.

To reflect your personal taste, the option of exterior Duo Tone paint allows customers to specify the vehicle in one of eight exterior colours² below the waistline, with a Santorini Black, Aruba or Eiger Grey finish above the waistline to produce a prestigious appearance.









INTERIOR

Having operated the power close rear doors from fully open at the touch of a button, the interior of SVAutobiography Long Wheelbase is revealed as the epitome of refined, sophisticated and indulgent living. Attention to the minutiae is in everything you see and touch. From the rear centre console's power deployable tables to the exclusive Diamond Quilted leather seats and rear seat refrigerated compartment, the vehicle exudes confidence and a calm, collected air.

A knurled finish to interior features such as the Stop/Start button, Zenith clock, rotary shifter and armrest adjusters, all add to the refined look. The leather-wrapped sides of the parcel shelf and loadspace, and Comfort Plus Executive Class seats come as standard. This ensures every journey is a truly relaxing experience.

The power deployable loadspace floor¹ is available in a veneer² or carpet finish to enhance this area of the vehicle, and can also be specified with an optional tailgate event seating system. This provides two comfortable luxury leather seats which mount in the tailgate when the vehicle is stationary for participating in outdoor events.

¹Not available with P400e PHEV engine. ²Loadspace floor veneer finish will match the interior veneer selected except with Copper Weave Carbon Fibre and Grand Black veneer, where the loadspace floor will have a Black Burr Ash veneer finish.

SPECIFICATIONS



CHOOSE YOUR MODEL

Each model has a choice of engines and distinctive features. This guide will help you to select your ideal Range Rover. On the following pages you'll see the standard features for each model.

To find out more and see your model specification, configure your Range Rover at landrover.co.uk



MODEL AVAILABILITY	VOGUE	VOGUE SE	AUTOBIOGRAPHY	SVAUTOBIOGRAPHY DYNAMIC	SVAUTOBIOGRAPHY LONG WHEELBASE
Standard Wheelbase	■	■	■	■	-
Long Wheelbase	-	-	■	-	■



STANDARD FEATURES FOR ALL MODELS

DYNAMICS

- 8-speed Automatic Transmission
- Twin-speed transfer box
- All Wheel Drive (AWD)
- Adaptive Dynamics
- Electronic Power Assisted Steering (EPAS)
- Dynamic Stability Control (DSC)
- Low Traction Launch
- Electronic Traction Control (ETC)
- Roll Stability Control (RSC)
- Cornering Brake Control (CBC)
- Automatic Access Height
- Hill Descent Control (HDC)
- Electronic air suspension
- Electric Parking Brake (EPB)
- Electronic Brake-force Distribution (EBD).

EXTERIOR FEATURES

- Acoustic laminated windscreen
- Rain sensing windscreen wipers
- Rear wash wiper
- Winter wiper park position
- Fixed panoramic roof
- Laminated front and rear side glass.

EXTERIOR LIGHTING

- Automatic headlights
- Daytime Running Lights (DRL)
- LED tail lights
- Follow me home lighting
- Centre high mounted stop light
- Headlight power wash.

WHEELS AND TYRES

- Tyre Pressure Monitoring System (TPMS)
- Locking wheel nuts.

TOWING

- Trailer Stability Assist (TSA)
- Electrical towing preparation
- Front and rear recovery eyes.

INTERIOR FEATURES

- Multi-function steering wheel
- Electrically adjustable steering column
- Sunvisors with illuminated vanity mirrors
- Electric windows with one-touch open/close and anti-trap
- Lockable glovebox
- Front and rear cupholders
- Front and rear grab handles.

CONVENIENCE

- Push Button Start
- Front centre console cooler compartment
- Driver and passenger front seat armrests
- Rear centre armrest
- Loadspace light
- Loadspace cover
- Easy boot loading
- Luggage tie-downs in loadspace
- Powered gesture tailgate.

INFOTAINMENT

- Touch Pro Duo
- 12.3" Interactive Driver Display
- Navigation Pro
- Protect
- Pro Services and 4G Wi-Fi Hotspot
- Remote Premium
- Secure Tracker
- Voice control
- 12V power sockets
- USB sockets
- Bluetooth® connectivity
- Digital Audio Broadcast (DAB) radio
- Smartphone Pack.

DRIVER ASSISTANCE

- Emergency Braking
- Cruise Control and Speed Limiter
- Front and Rear Parking Aid.

SAFETY

- Emergency Brake Assist (EBA)
- Intrusion sensor
- Anti-lock Braking System (ABS)
- Customer configurable autolock
- Height adjustable seatbelts
- Customer configurable single point entry
- Power operated child locks
- Rear ISOFIX
- Front airbags with passenger seat occupant detector
- Front side airbags.

VOGUE





VOGUE
(IN ADDITION TO STANDARD FEATURES)

DYNAMICS	- Terrain Response.
WHEELS	- 20" Style 1065, 12 spoke, Gloss Silver - Reduced section alloy spare wheel*.
EXTERIOR FEATURES	- Atlas grille mesh foil and inner surround with Narvik Black frame - Atlas front bumper accent - Satin body-coloured front bumper vent finisher - Satin body-coloured side vent graphic and side accent graphic - Eiger Grey tow eye cover - Atlas tailgate finisher - Heated windscreen - Power fold, heated door mirrors with memory and approach lights - Auto-dimming exterior mirrors.
EXTERIOR LIGHTING	- Matrix LED headlights with signature DRL.
INTERIOR FEATURES	- Perforated Windsor leather seats - 20-way heated front seats with power recline heated rear seats - Shadow Walnut veneer - Morzine headlining - Heated steering wheel - Carpet mats - Twin-blade sunvisors with illuminated vanity mirrors - Aluminium treadplates with Range Rover script.
CONVENIENCE	- Three-zone Climate Control - Powered gesture tailgate - Keyless Entry.
INFOTAINMENT	- Meridian™ Sound System - Digital TV.
DRIVER ASSISTANCE	- Lane Departure Warning.

*Except P400e which is supplied with Tyre Repair System.

VOGUE SE





VOGUE SE (IN ADDITION TO STANDARD FEATURES)

DYNAMICS	<ul style="list-style-type: none"> - Terrain Response 2 - All Terrain Progress Control (ATPC)¹
WHEELS	<ul style="list-style-type: none"> - 21" Style 7001, 7 split-spoke, Gloss Silver - Reduced section alloy spare wheel².
EXTERIOR FEATURES	<ul style="list-style-type: none"> - Atlas grille mesh foil and inner surround with Narvik Black frame - Atlas front bumper accent - Satin body-coloured front bumper vent finisher - Satin body-coloured side vent graphic and side accent graphic - Atlas door handle surrounds - Eiger Grey tow eye cover - Atlas tailgate finisher - Heated windscreen - Power fold, heated door mirrors with memory and approach lights - Auto-dimming exterior mirrors.
EXTERIOR LIGHTING	<ul style="list-style-type: none"> - Matrix LED headlights with signature DRL.
INTERIOR FEATURES	<ul style="list-style-type: none"> - Perforated Semi-Aniline leather seats - 20-way heated and cooled front seats with power recline heated and cooled rear seats - Kalahari veneer - Morzine headlining - Heated steering wheel - Carpet mats - Twin-blade sunvisors with illuminated vanity mirrors - Aluminium treadplates with Range Rover script.
CONVENIENCE	<ul style="list-style-type: none"> - Three-zone Climate Control - Configurable Ambient Interior Lighting - Soft door close - Powered gesture tailgate - Keyless Entry.
INFOTAINMENT	<ul style="list-style-type: none"> - Meridian™ Surround Sound System - Digital TV.
DRIVER ASSISTANCE	<ul style="list-style-type: none"> - Blind Spot Monitor - Driver Condition Monitor - Traffic Sign Recognition and Adaptive Speed Limiter - Lane Departure Warning - Clear Exit Monitor - 360° Parking Aid - Rear Traffic Monitor.

¹Not available on P400e. ²Except P400e which is supplied with Tyre Repair System.
Features additional to the previous model are highlighted in bold.

AUTOBIOGRAPHY





AUTOBIOGRAPHY
(IN ADDITION TO STANDARD FEATURES)

DYNAMICS	<ul style="list-style-type: none"> - Terrain Response 2 - All Terrain Progress Control (ATPC)¹. 	
WHEELS	<ul style="list-style-type: none"> - 21" Style 7001, 7 split-spoke, Gloss Light Silver with contrast Diamond Turned finish - Reduced section alloy spare wheel². 	
EXTERIOR FEATURES	<ul style="list-style-type: none"> - Atlas grille mesh foil and inner surround with Narvik Black frame - Atlas front bumper accent and front bumper vent finisher - Atlas side vent graphic and side accent graphic - Atlas door handle surrounds - Eiger Grey tow eye cover 	<ul style="list-style-type: none"> - Atlas tailgate finisher - Heated windscreen - Sliding panoramic roof - Power fold, heated door mirrors with memory and approach lights - Auto-dimming exterior mirrors.
EXTERIOR LIGHTING	<ul style="list-style-type: none"> - Pixel LED headlights with signature DRL - Front fog lights. 	
INTERIOR FEATURES	<ul style="list-style-type: none"> - Perforated Semi-Aniline leather seats - 24-way heated and cooled, massage front seats with Executive Class rear seats - Satin Straight Walnut veneer - Suede cloth headlining - Heated steering wheel 	<ul style="list-style-type: none"> - Premium carpet mats - Twin-blade sunvisors with illuminated vanity mirrors - Illuminated aluminium treadplates with Autobiography script.
CONVENIENCE	<ul style="list-style-type: none"> - Four-zone Climate Control - Configurable Ambient Interior Lighting - Powered gesture tailgate 	<ul style="list-style-type: none"> - Soft door close - Keyless Entry.
INFOTAINMENT	<ul style="list-style-type: none"> - Meridian™ Surround Sound System - Digital TV. 	
DRIVER ASSISTANCE	<ul style="list-style-type: none"> - 360° Surround Camera - Blind Spot Assist - Adaptive Cruise Control with Steering Assist - Driver Condition Monitor - Lane Keep Assist 	<ul style="list-style-type: none"> - Traffic Sign Recognition and Adaptive Speed Limiter - Clear Exit Monitor - 360° Parking Aid - Park Assist - Rear Traffic Monitor.
LONG WHEELBASE FEATURES	<ul style="list-style-type: none"> - Laminated front and laminated privacy rear side glass - Solar attenuating windscreen 	<ul style="list-style-type: none"> - Electric rear side window sunblinds - CD/DVD player - 10" Rear Seat Entertainment.

¹Not available on P400e. ²Except P400e which is supplied with Tyre Repair System. Features additional to the previous model are highlighted in bold.

SVAUTOBIOGRAPHY DYNAMIC





SVAUTOBIOGRAPHY DYNAMIC
(IN ADDITION TO STANDARD FEATURES)

DYNAMICS	<ul style="list-style-type: none"> - Terrain Response 2 - All Terrain Progress Control (ATPC) - Dynamic Response 	<ul style="list-style-type: none"> - Red brake calipers - Unique SVAutobiography integrated metal tailpipe finishers.
WHEELS	<ul style="list-style-type: none"> - 22" Style 5087, 5 split-spoke, Gloss Dark Grey with contrast Diamond Turned finish - Full size spare wheel. 	
EXTERIOR FEATURES	<ul style="list-style-type: none"> - Exclusive SVAutobiography grille consisting of: Graphite Atlas grille mesh foil with Bright Chrome inserts, Bright Chrome inner surround and Narvik Black frame - Graphite Atlas front bumper accent and front bumper vent finisher - Graphite Atlas side vent graphic with Bright Chrome inserts and Graphite Atlas side accent graphic - Bright Chrome door handle surrounds 	<ul style="list-style-type: none"> - Indus Silver tow eye cover - Graphite Atlas tailgate finisher - Heated windscreen - Black contrast roof - Sliding panoramic roof - Power fold, heated door mirrors with memory and approach lights - Auto-dimming exterior mirrors - Privacy glass.
EXTERIOR LIGHTING	<ul style="list-style-type: none"> - Pixel-laser LED headlights with signature DRL - Front fog lights. 	
INTERIOR FEATURES	<ul style="list-style-type: none"> - Quilted perforated Semi-Aniline leather seats - 24-way heated and cooled, enhanced massage front seats with Executive Class Comfort Plus rear seats - Steel Weave Carbon Fibre trim finisher - Perforated leather headlining - Heated steering wheel 	<ul style="list-style-type: none"> - Premium carpet mats - Twin-blade sunvisors with illuminated vanity mirrors - Illuminated aluminium treadplates with illuminated SVAutobiography script - SVAutobiography pedals with knurled effect.
CONVENIENCE	<ul style="list-style-type: none"> - Four-zone Climate Control - Configurable Ambient Interior Lighting - Powered gesture tailgate 	<ul style="list-style-type: none"> - Soft door close - Keyless Entry.
INFOTAINMENT	<ul style="list-style-type: none"> - Meridian™ Signature Sound System - Digital TV. 	
DRIVER ASSISTANCE	<ul style="list-style-type: none"> - 360° Surround Camera - Lane Keep Assist - Blind Spot Assist - Driver Condition Monitor - Adaptive Cruise Control with Steering Assist 	<ul style="list-style-type: none"> - Park Assist - 360° Parking Aid - Clear Exit Monitor - Rear Traffic Monitor - Traffic Sign Recognition and Adaptive Speed Limiter.

SV AUTOBIOGRAPHY LONG WHEELBASE

Range Rover SVAutobiography Long Wheelbase is exquisitely crafted. The epitome of luxury, this vehicle offers a range of exclusive interior and exterior features, together with a stunning choice of options that elevate its refinement and elegance to the very highest levels.





SVAUTOBIOGRAPHY LONG WHEELBASE

DYNAMICS	<ul style="list-style-type: none"> - Terrain Response 2 - All Terrain Progress Control (ATPC)¹ - Dynamic Response¹ 	<ul style="list-style-type: none"> - Gloss Black brake calipers² - Exclusive SVAutobiography integrated metal tailpipe finishers (with V8 Supercharged engine only).
WHEELS	<ul style="list-style-type: none"> - 21" Style 7006, 7 spoke, High Gloss Grey with Polished finish 	<ul style="list-style-type: none"> - Reduced section alloy spare wheel².
EXTERIOR FEATURES	<ul style="list-style-type: none"> - Exclusive SVAutobiography grille¹ consisting of: Atlas grille mesh foil with Bright Chrome inserts, Bright Chrome inner surround and Narvik Black frame - Atlas front bumper accent and front bumper vent finisher - Body colour side vent graphic with Bright Chrome inserts and Atlas side vent graphic - Bright Chrome door handle surrounds 	<ul style="list-style-type: none"> - Indus Silver tow eye cover - Bright Chrome tailgate finisher - Heated windscreen - Sliding panoramic roof - Power fold, heated door mirrors with memory and approach lights.
EXTERIOR LIGHTING	<ul style="list-style-type: none"> - Pixel-laser LED headlights with signature DRL - Front fog lights. 	
INTERIOR FEATURES	<ul style="list-style-type: none"> - Quilted perforated Semi-Aniline leather seats - 24-way heated and cooled, enhanced massage front seats with fixed centre console Executive Class Comfort Plus rear seats - Satin Santos Palisander veneer - Perforated leather headlining - Deployable tables with wood finish - Front centre console refrigerator compartment and rear seat refrigerator compartment - Heated steering wheel 	<ul style="list-style-type: none"> - Mohair mats with leather binding - Twin-blade sunvisors with illuminated vanity mirrors - Illuminated aluminium treadplates with illuminated SVAutobiography script - SVAutobiography pedals with knurled effect. - Power deployable loadspace floor with veneer finish¹ - Full length rear centre console with Zenith clock.
CONVENIENCE	<ul style="list-style-type: none"> - Four-zone Climate Control - Configurable Ambient Interior Lighting - Powered gesture tailgate 	<ul style="list-style-type: none"> - Power close rear doors from fully open position - Keyless Entry - Soft door close.
INFOTAINMENT	<ul style="list-style-type: none"> - Meridian™ Signature Sound System 	<ul style="list-style-type: none"> - Digital TV.
DRIVER ASSISTANCE	<ul style="list-style-type: none"> - 360° Surround Camera - Lane Keep Assist - Blind Spot Assist - Driver Condition Monitor - Adaptive Cruise Control with Steering Assist 	<ul style="list-style-type: none"> - Park Assist - 360° Parking Aid - Clear Exit Monitor - Rear Traffic Monitor - Traffic Sign Recognition and Adaptive Speed Limiter.

¹Not available with P400e PHEV engine. ²Not available with SDV8 or P400e PHEV engine.



CHOOSE YOUR ENGINE

WHICH ENGINE IS RIGHT FOR YOU?

Lots of people struggle with this. But the truth is that it really depends on what your priorities are and the type of driving you do. Diesel engines are more powerful than petrol engines. They have a higher torque and so give a smoother drive. And they're more fuel-efficient than petrol, particularly out of town on long journeys. On the other hand, the harshness, noise, and vibrations in diesel-driven cars are higher than that of a petrol-driven car. Also, the maintenance cost of diesel cars is greater. Petrol cars are generally quieter and cheaper to run on shorter journeys. Plug-in Hybrid Electric Vehicles (PHEV) meanwhile provide all-electric performance at lower speeds and traditional combustion performance on longer journeys.

DIESEL ENGINES

SDV6

The Turbocharged Diesel engine produces 275HP and 625Nm of torque and is ideal for higher power and torque demand usage with exceptional driveability.

- The innovative parallel sequential twin turbochargers - a concept pioneered by Jaguar Land Rover - feature a ceramic ball bearing on the primary turbo to reduce friction for maximum throttle response.
- A switchable coolant pump and two-stage oil pump are used for optimal thermal energy management, improving operating efficiency.
- The piezo common rail fuel injection system enables precise control of the amount of fuel injected creating a uniform mixture for more efficient combustion and less emissions.
- The engine utilises these technologies to offer premium refinement and performance.

SDV8

The 4.4 litre V8 Twin Turbocharged Diesel offers top-of-the-range performance, with 339HP and a staggering 740Nm of torque between 1,750-2,250rpm.

- Helical and tangential inlet ports for low-speed swirl and high gas flow, with combustion chambers optimised for emissions performance.
- 2000 bar common rail fuel injection with Gen 3 Piezo injectors.
- Compounded Graphite Iron Block with optimised thin wall section and aluminium alloy heads.
- Twin overhead camshafts and 4 valves per cylinder.



PETROL ENGINES

P400

The 3.0 litre Ingenium In-line 6-cylinder Petrol engine produces 400HP and 550Nm of torque. The combination of MHEV technology and a range of efficiency measures deliver an engine of superb performance and driveability whilst delivering impressively low CO₂ emissions and high fuel economy.

- Mild Hybrid Electric Vehicle (MHEV) technology utilises a belt-driven integrated starter-generator, a 48V Lithium-ion battery and an electric supercharger for driveability, economy and refined Stop/Start operation.
- The twin-scroll Turbocharger, in addition to the electric Supercharger, delivers additional engine boost at higher engine speeds and seamless power delivery.
- Variable cam timing on both the intake and exhaust camshafts allows the nominal cam profile to be advanced or retarded for optimum combustion. Combined with Continuous Variable Valve Lift, this delivers class-leading levels of flexibility and control over engine breathing to maximise efficiency at every operating condition, enhancing both performance and fuel economy.

P525

With 525HP and 625Nm of torque, the 5.0 litre V8 Supercharged Petrol engine provides top-of-the-range performance for ultimate refinement and driver engagement.

- The V8 has a compact and lightweight all-aluminium design, with impressively low levels of internal friction.
- The engine has been optimised around a state-of-the-art engine management system. This features high pressure direct injection with a centrally mounted, multi-hole, spray-guided injection system.
- Fitted with a sixth generation Twin Vortex System (TVS) supercharger, the engine offers superior thermodynamic efficiency and extremely refined noise levels. The supercharger fully utilises the additional capacity of the 5.0 litre engine, generating a torque profile that delivers outstanding levels of power in a linear and engaging manner.
- The result is an impressively powerful yet refined drivetrain that delivers on both sporting excitement and luxurious refinement whenever required.

V8 SUPERCHARGED 565HP

Exclusive to SVAutobiography Dynamic and SVAutobiography Long Wheelbase, the 5.0 litre V8 Supercharged Petrol engine has been updated to deliver 565HP and 700Nm of torque. This is enabled by a recalibration of the engine and its management system to increase maximum available boost pressure. Maximum torque is delivered at 6,000-6,500rpm. Refer to V8 Supercharged Petrol engine for full details.



CHOOSE YOUR EXTERIOR

SELECT YOUR ROOF

Choose from a metal roof¹, or a fixed panoramic or sliding panoramic roof – both of which enhance the sense of space in the vehicle's interior and flood it with natural light. The fixed panoramic roof provides uninterrupted views of the surrounding environment. The sliding panoramic roof opens fully to let the outside in. You can select either a body-coloured or contrast roof in Narvik Black to further enhance your vehicle's exterior. Metal and panoramic roofs available with all colour finishes.



Fixed panoramic roof
optional²



Sliding panoramic roof
optional³



Body-coloured roof
standard



Black contrast roof
optional



SELECT YOUR PAINT COLOUR

Now you have chosen your preferred roof style, you can select your exterior paint colour. From rich, deep lustres to incandescent metallic patinas, our paints incorporate the latest in pigment technologies. Our Solid paints produce a deep flat colour. Our Metallics deliver a Sparkle finish that is sure to catch the eye. And our optional Premium Metallic paints enhance both the colour and the intensity of the finish to give your vehicle even more presence.

SOLID



Narvik Black



Fuji White

METALLIC



Santorini Black

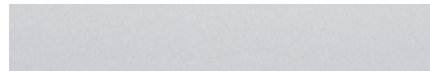

Yulong White



Eiger Grey



Indus Silver



Byron Blue



Portofino Blue



Firenze Red⁴



Rosello Red

PREMIUM METALLIC



Carpathian Grey



Silicon Silver

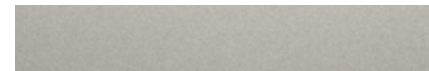

Aruba

⁴Black contrast roof standard. Only available on SVAutobiography Dynamic.



SPECIAL VEHICLE OPERATIONS

SVO PREMIUM PAINT PALETTE

An optional range of specifically formulated ultra Metallic and special effect Premium Palette colours and finishes are available. Additionally, Bespoke by SVO offers a combination of colours and finishes and will colour-match to your exact requirement using our Match-to-Sample service. All special effect colours come in a Gloss finish or, as an additional option, Satin Matte finish. SVAutobiography Long Wheelbase is available with the option of an exclusive Duo Tone finish in eight standard combinations, or as a further option, in Premium Paint Palette colours for the ultimate in personal expression.

To find out more visit landrover.co.uk to configure your vehicle online.

ULTRA METALLIC



Ligurian Black



Bosphorus Grey¹



British Racing Green¹



Madagascar Orange¹



Rio Gold¹



Mescalito Black



Scafell Grey¹



Balmoral Blue¹



Velocity Blue¹



Verbier Silver¹



Borealis Black



Windward Grey¹



Desire Deep Red¹



Flux Silver¹



Ethereal Frost Silver¹

SPECIAL EFFECT



Spectral British Racing Green¹



Spectral Racing Red¹



Spectral Blue¹



Meribel White Pearl¹

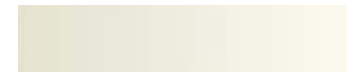

Valloire White Pearl¹

DUO TONE



Santorini Black/Eiger Grey



Santorini Black/Indus Silver



Santorini Black/Yulong White



Aruba/Silicon Silver

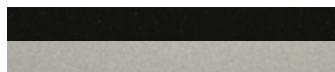

Santorini Black/Aruba



Santorini Black/Rosello Red



Santorini Black/Portofino Blue



Eiger Grey/Carpathian Grey



SELECT YOUR RANGE ROVER DESIGN PACK

You can tailor the exterior of your Range Rover with the addition of two packs: Shadow Exterior Pack or Black Exterior Pack. Each one elevates the vehicle's sense of sophistication, with specific detailing also helping to add another level of individuality. Whichever pack you choose, it will add greatly to your Range Rover.

SHADOW EXTERIOR PACK



Optional pack on Vogue, Vogue SE and Autobiography only

- Shadow Atlas bonnet and tailgate lettering
- Shadow Atlas grille mesh foil, inner surround and frame
- Shadow Atlas front bumper vent finisher² and front bumper accent
- Shadow Atlas door handle surrounds³
- Shadow Atlas side vent graphic and side accent graphic
- Shadow Atlas tailgate finisher.

BLACK EXTERIOR PACK



Optional pack on Vogue, Vogue SE and Autobiography only

- Narvik Black bonnet and tailgate lettering
- Narvik Black grille mesh foil, inner surround and frame
- Narvik Black front bumper vent finisher² and front bumper accent
- Narvik Black front tow eye cover
- Narvik Black door mirror caps
- Narvik Black door handle surrounds³
- Narvik Black side vent graphic and side accent graphic
- Narvik Black tailgate finisher
- Choice of 21" or 22" Gloss Black alloy wheels.

²Autobiography only. ³Vogue SE and Autobiography only.

Features and their availability may differ by vehicle specification. For full feature and option availability please refer to the accompanying Specification and Price Guide or visit your local Land Rover Retailer.

Vehicles shown in Byron Blue with optional features.

CHOOSE YOUR WHEELS

There are 17 wheel styles to choose from. Sizes range from 19" to the highly desirable 22". With distinctive design cues, each one adds its own character to the overall look of the vehicle.

To see the wheels available on your model visit the configurator at landrover.co.uk



19" STYLE 5001,
5 SPLIT-SPOKE,
GLOSS SILVER (1)



20" STYLE 1065,
12 SPOKE,
GLOSS SILVER (5)



21" STYLE 7001,
7 SPLIT-SPOKE,
GLOSS SILVER



21" STYLE 6002,
6 SPOKE,
GLOSS SILVER



21" STYLE 9001,
9 SPOKE,
GLOSS BLACK (3)



21" STYLE 5005,
5 SPLIT-SPOKE,
GLOSS DARK GREY (2)



21" STYLE 7001,
7 SPLIT-SPOKE, GLOSS LIGHT SILVER
WITH CONTRAST
DIAMOND TURNED FINISH



21" STYLE 6002,
6 SPOKE, GLOSS LIGHT SILVER
WITH CONTRAST
DIAMOND TURNED FINISH



21" STYLE 7006,
7 SPOKE, HIGH GLOSS GREY
WITH POLISHED FINISH (6)



22" STYLE 9012,
9 SPLIT-SPOKE,
GLOSS BLACK (3) (4) (7)



22" STYLE 9012,
9 SPLIT-SPOKE, GLOSS DARK GREY
WITH CONTRAST
DIAMOND TURNED FINISH (4)



22" STYLE 5004,
5 SPLIT-SPOKE,
GLOSS SILVER (4)



22" STYLE 5004,
5 SPLIT-SPOKE,
GLOSS BLACK (1)



22" STYLE 7007,
7 SPLIT-SPOKE, GLOSS DARK GREY
WITH CONTRAST
DIAMOND TURNED FINISH (4)



22" STYLE 7018,
7 SPLIT-SPOKE, GLOSS LIGHT SILVER
WITH DYNAMIC POLISHED FINISH (6)



22" STYLE 1046,
11 SPOKE,
GLOSS SILVER (4)



22" STYLE 5087,
5 SPLIT-SPOKE, GLOSS DARK GREY
WITH CONTRAST
DIAMOND TURNED FINISH (2)

CHOOSE YOUR INTERIOR

BENCH SEAT



SELECT YOUR SEAT CONFIGURATION

Bench Seat

Arrive in style. The leather seating in Range Rover is both truly comfortable and effortlessly versatile. The 60:40 configuration with load-through facility is available with a powered recline on Vogue, Vogue SE and Autobiography. All bench seats include Passenger Seat Away.

The powered recline variant also provides Intelligent Seat Fold, offering the ability to fold and configure your seats from the loadspace. Seat comfort is heightened with the addition of heated and cooled¹ variants.

Rear Executive Class Seat

The ultimate in luxury, these seats provide exemplary levels of comfort. Featuring wider and deeper cushioning, the power deployable centre console integrates seamlessly with the two outer passenger seats, creating a luxury four-seat environment. If more versatility is required, simply retract the power deployable centre console to reveal a centre seat for a third occupant. Or for the first time, fold your rear Executive Class seats forward to maximise your loadspace. Featuring Extreme Passenger Seat Away and powered recline as standard, optional Comfort and Comfort Plus features, including 'Hot-Stone' massage and heated calf rests² create a truly luxurious environment. Available on Vogue SE, Autobiography, SVAutobiography Dynamic and SVAutobiography Long Wheelbase³.



REAR EXECUTIVE CLASS SEAT



	1	2	3	4	5
COLOURWAYS See page 86	DOOR LOWER	DOOR AND ARM REST UPPER	INSTRUMENT PANEL UPPER	INSTRUMENT PANEL MID	INSTRUMENT PANEL LOWER
A Navy/Ivory	Navy	Ivory	Navy	Ivory	Ivory
B Espresso/Ivory	Espresso	Ivory	Espresso	Ivory	Ivory
C Espresso/Almond	Espresso	Almond	Espresso	Almond	Almond
D Ebony/Ebony	Ebony	Ebony	Ebony	Ebony	Ebony
E Ebony/Ivory	Ebony	Ivory	Ebony	Ivory	Ivory
F Ebony/Vintage Tan	Ebony	Vintage Tan	Ebony	Vintage Tan	Vintage Tan
G Ebony/Pimento	Ebony	Pimento	Ebony	Pimento	Pimento
EXCLUSIVE TO SVAUTOBIOGRAPHY DYNAMIC					
H Ebony/Ebony	Ebony	Ebony	Ebony	Ebony	Ebony
I Ebony/Cirrus	Ebony	Cirrus	Ebony	Cirrus	Ebony
J Ebony/Vintage Tan	Ebony	Vintage Tan	Ebony	Vintage Tan	Ebony
K Ebony/Pimento	Ebony	Pimento	Ebony	Pimento	Ebony

EXCLUSIVE TO SVAUTOBIOGRAPHY LONG WHEELBASE

The beautifully sophisticated interior is offered in quilted perforated Semi-Aniline leather with Poltrona Frau leather available as an exclusive option. Both of these premium leathers can be specified in a range of new colourways including Navy/Cirrus and Vintage Tan. Two SVAutobiography interior trims – Satin Santos Palisander and Copper Weave Carbon Fibre – are available exclusively, alongside the standard veneer and finisher options, which can be seen on page 87.



Power close rear doors further set this vehicle apart and are effortlessly operated by the touch of a button on the rear centre console. Ensuring even higher levels of elegance and comfort, features include the rear seat refrigerated compartment with veneered sliding electric door and electrically deployable tables.



INTERIOR COLOUR COMBINATIONS

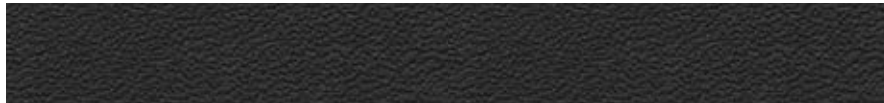

Ebony/Ebony

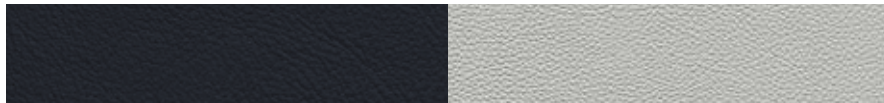

Navy/Cirrus

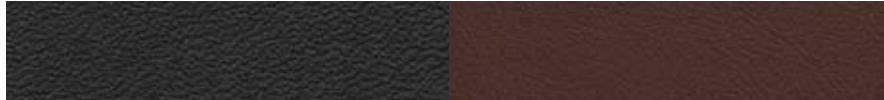

Ebony/Brogue



Vintage Tan



Ebony/Ivory

INTERIOR FINISHERS¹



Satin Santos Palisander²



Copper Weave Carbon Fibre²

¹All standard interior finishers are also available on SVAutobiography Long Wheelbase except Steel Weave Carbon Fibre - see page 87.
²Available on SVAutobiography Long Wheelbase models only.

SELECT YOUR INTERIOR COLOUR COMBINATION

Now you have chosen your model, you can select the perfect combination of interior colours.



A. Navy/Ivory

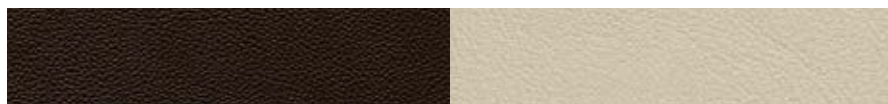

B. Espresso/Ivory

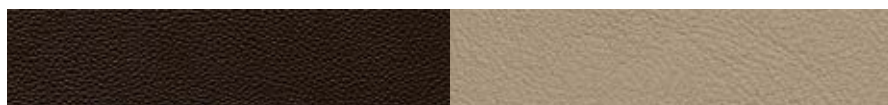

C. Espresso/Almond



D. Ebony/Ebony

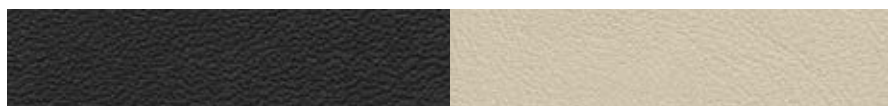

E. Ebony/Ivory



F. Ebony/Vintage Tan



G. Ebony/Pimento

EXCLUSIVE TO SVAUTOBIOGRAPHY DYNAMIC



H. Ebony/Ebony



I. Ebony/Cirrus



J. Ebony/Vintage Tan



K. Ebony/Pimento



SELECT YOUR INTERIOR FINISHER

Now you've chosen your interior colour combination, choose one of nine interior finishers that are beautifully displayed in the cabin.



Grand Black veneer

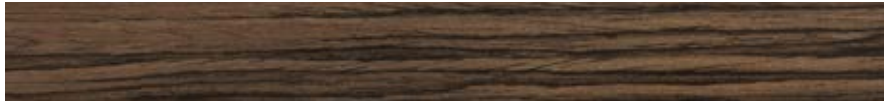

Kalahari veneer



Satin Straight Walnut veneer



Shadow Walnut veneer



Black Burr Ash veneer

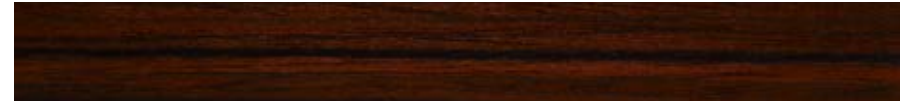

Figured Macassar veneer



Argento Pinstripe veneer



Steel Weave Carbon Fibre trim finisher¹

EXECUTIVE CLASS SEATS ONLY



Grand Black with Cut Diamond Motif Metallic Inlay Effect veneer²

¹Only available on SVAutobiography Dynamic. ²When Grand Black veneer is selected with Executive Class seats, the rear power deployable centre console will contain a Grand Black with Cut Diamond Motif Metallic Inlay Effect veneer.

The availability of interior finishers varies by vehicle specification. For full availability please refer to the accompanying Specification and Price Guide or visit your local Land Rover Retailer.

SELECT YOUR SEAT

Range Rover's seats are available in a range of leathers and colourways. Beautifully designed, they further enhance the sophisticated interior whilst ensuring exemplary levels of comfort.

Note: not all configurations can be shown here, please configure your choices online at landrover.co.uk



Perforated Windsor leather



Perforated Semi-Aniline leather

COLOURWAYS	EBONY/EBONY		EBONY/IVORY		ESPRESSO/ALMOND		NAVY/IVORY		ESPRESSO/IVORY		EBONY/VINTAGE TAN	EBONY/PIMENTO
INTERIOR												
Seat colour	Ebony	Ebony	Ivory	Ebony	Espresso	Almond	Navy	Ivory	Espresso	Ivory	Vintage Tan	Pimento
Carpet	Ebony	Ebony	Ebony	Ebony	Espresso	Espresso	Navy	Navy	Espresso	Espresso	Ebony	Ebony
MODEL SEAT MATERIAL												
Vogue	Perforated Windsor leather	<input type="checkbox"/>	<input type="checkbox"/>	<input type="checkbox"/>	<input type="checkbox"/>	<input type="checkbox"/>	<input type="checkbox"/>	<input type="checkbox"/>	<input type="checkbox"/>	<input type="checkbox"/>	-	-
Vogue SE	Perforated Semi-Aniline leather	<input type="checkbox"/>	<input type="checkbox"/>	<input type="checkbox"/>	<input type="checkbox"/>	<input type="checkbox"/>	<input type="checkbox"/>	<input type="checkbox"/>	<input type="checkbox"/>	<input type="checkbox"/>	<input type="checkbox"/>	<input type="checkbox"/>
Autobiography	Perforated Semi-Aniline leather	<input type="checkbox"/>	<input type="checkbox"/>	<input type="checkbox"/>	<input type="checkbox"/>	<input type="checkbox"/>	<input type="checkbox"/>	<input type="checkbox"/>	<input type="checkbox"/>	<input type="checkbox"/>	<input type="checkbox"/>	<input type="checkbox"/>

Optional - Not Available.



Quilted Perforated Semi-Aniline leather



Quilted Poltrona Frau leather

COLOURWAYS	EXCLUSIVE TO SVAUTOBIOGRAPHY DYNAMIC				EXCLUSIVE TO SVAUTOBIOGRAPHY LONG WHEELBASE				
	EBONY/ EBONY	EBONY/ CIRRUS	EBONY/ VINTAGE TAN	EBONY/ PIMENTO	EBONY/ EBONY	NAVY/ CIRRUS	EBONY/ BROGUE	VINTAGE TAN/ VINTAGE TAN	EBONY/ IVORY
INTERIOR									
Seat colour	Ebony	Ebony/Cirrus	Ebony/Vintage Tan	Ebony/Pimento	Ebony	Cirrus	Brogue	Vintage Tan	Ivory
Carpet	Ebony	Ebony	Ebony	Ebony	Ebony	Navy	Ebony	Vintage Tan	Ebony
MODEL	SEAT MATERIAL								
SVAutobiography Dynamic	Quilted perforated Semi-Aniline leather	<input type="checkbox"/>	<input type="checkbox"/>	<input type="checkbox"/>	<input type="checkbox"/>	-	-	-	-
SVAutobiography Long Wheelbase	Quilted perforated Semi-Aniline leather	-	-	-	-	<input type="checkbox"/>	<input type="checkbox"/>	<input type="checkbox"/>	<input type="checkbox"/>
	Quilted Poltrona Frau leather	-	-	-	-	<input type="checkbox"/>	<input type="checkbox"/>	<input type="checkbox"/>	<input type="checkbox"/>



CHOOSE YOUR OPTIONS AND LAND ROVER GEAR

A wealth of line-fit options are available to select from at the point of ordering your new vehicle to help you express your individuality and appoint your Range Rover with the premium features you require. Features and their availability may differ by vehicle specification and market. For full feature and option availability and linked options, please refer to the accompanying Specification and Price Guide or visit your local Land Rover Retailer.





EXTERIOR FEATURES

Soft door close (see page 48)

Privacy glass

Solar attenuating windscreen to reduce temperature build-up within cabin

Roof options (see page 76)

Exterior styling (see page 79)

Satin body-coloured exterior accents - Satin body-coloured side vent graphic and side accent graphic

Atlas exterior accents - Atlas side vent graphic and side accent graphic

Carbon Fibre engine cover

(SVAutobiography Dynamic only).

EXTERIOR LIGHTING

See page 47

Front fog lights

Vision Assist Pack - Front fog lights, Configurable Ambient Interior Lighting (see page 13), Head-up Display (see page 29).

WHEELS AND TYRES

See pages 80-81

Full size spare wheel.

INTERIOR FEATURES

Premium carpet mats*

Wood and leather steering wheel

Illuminated aluminium treadplates with Range Rover script*

First and second row Smoker's Pack - Includes cigar lighter and removable ash can in first row, and cigar lighter and ash can in second row

Front centre console refrigerator compartment

Four-zone Climate Control (see page 48)

Cabin Air Ionisation (see page 48)

Hot Climate Pack - Solar attenuating windscreen, front centre console refrigerator compartment, Four-zone Climate Control.

SEATING AND INTERIOR TRIM

Ebony Morzine headlining

Leather headlining (only with sliding panoramic roof)

Suedecloth headlining.

Front seats: 20/22/24-way, heated, cooled, massage, power recline

Rear seats: heated, cooled, massage, rear Executive Class seats

Windsor leather, Semi-Aniline leather, quilted Semi-Aniline leather, Quilted Poltrona Frau leather (SVAutobiography Long Wheelbase only).

DYNAMICS

All Terrain Progress Control (ATPC) (see page 27)

Terrain Response 2 (see page 25)

Active Locking Rear Differential (see page 26)

Black brake calipers.

TOWING

See page 52

Electrically deployable tow bar¹ (not available on PHEV)
(see page 52)

Advanced Tow Assist (see page 52)

Towing Pack² - Electrically deployable tow bar,
Advanced Tow Assist, full size spare wheel, Activity Key²
(see page 49).

INFOTAINMENT

See pages 29-35

Domestic plug socket located in row 2 and loadspace

Entertainment Pack² - Meridian™ Surround Sound
System, CD/DVD player, 10" Rear Seat Entertainment,
domestic plug socket located in row 2 and loadspace

Signature Entertainment Pack² - Meridian™
Signature Sound System, CD/DVD player, 10" Rear
Seat Entertainment, domestic plug socket located
in row 2 and loadspace

Head-up Display (see page 29).

CONVENIENCE

Park Heat with remote control - enables pre-warming
of vehicle using remote control or timer

Garage Door Opener (HomeLink®)

Activity Key¹ (see page 49)

Secure Tracker Pro (see page 33).

DRIVER ASSISTANCE

360° Surround Camera (see page 38)

Wade Sensing (see page 27)

Adaptive Cruise Control (see page 36)

Adaptive Cruise Control with Steering Assist
(see page 41)

Drive Pack (see page 37)

Drive Pro Pack (see page 37)

Driver Assist Pack (see page 40)

Park Pack (see page 39)

Park Pro Pack (see page 39).

¹Also available as an accessory. Accessories can be fitted following the point of order or at any stage during the ownership period. ²Features contained within pack vary by model.

iPhone and iPad® is a registered trademark of Apple Inc., registered in the US and other countries.

HomeLink® is a registered trademark of Gentex Corporation.



LAND ROVER GEAR – ACCESSORIES

DESIGN

SVO Design Pack³

SVO design packs provide a purposeful, dynamic and stunning styling enhancement that allow customers to add their own stamp of individuality by tailoring their Range Rover. Exterior features include a unique front bumper with integrated tailpipes, side vents, grille and side sill claddings.

Noble Chrome Mirror Covers

Noble Chrome plated mirror covers designed to enhance the Range Rover's exterior styling cues. This neat styling upgrade complements various Dark Atlas, Light Atlas and Bright finish exterior trims.

Sport Pedal Kit

Alternative pedal covers for an interior styling enhancement featuring a Bright finish. Manufactured from polished and etched stainless steel and features hidden fixings for a clean finish.

Illuminated Treadplates

Illuminated treadplates with Range Rover lettering and halo surround. Rear treadplates feature illuminated halo only.

Personalised Illuminated Treadplates

Personalised illuminated treadplates allow you to choose a personalised message using an approved set of fonts/typefaces which will be highlighted in white illumination when the front doors are open.

Gearshift Paddles

Complete the look and feel of your steering wheel with premium aluminium paddles. Gearshift paddles are machine polished, anodised and hand brushed to provide exceptional wear resistance with a premium finish.



SVO Design Pack

LIFESTYLE

Deployable Side Steps

These smart, practical steps make it easier to get in and out of the vehicle. Neatly stowed under the sills, the side steps automatically deploy as soon as the door is opened, or when activated by the key fob. They stow automatically when the door is closed. The side steps are sensitive to obstructions and will not deploy in off-road or low range settings. Automatic mode can be overridden to allow access to the roof when the doors are closed. The deployable side steps are compatible with front mudflaps and feature a Stainless Steel finish with laser etched Range Rover branding.

Fixed Side Steps

Complete with a rubber tread mat and Brushed Stainless Steel trim, the fixed side steps provide easy access/exit to the vehicle's cabin and aid access to the roof. With embossed Range Rover branding, exterior Bright work and Bright anodised aluminium edge trim finish, they complement the vehicle's exterior styling cues.

Rubber Mats

Rubber footwell mats for front and second row occupants help provide protection from general dirt. Featuring Bright accent Range Rover ingot and durable metal corner pieces.

Click & Go System

The Click & Go range is a multi purpose seat-back system for second row passengers. The versatile Click & Go base fixes between the headrest mountings and further attachments can be added to hold tablets, bags and shirts or jackets. Each attachment is sold separately. The base can be easily removed when not in use.



Deployable Side Steps

³Offered for SWB only. Only applicable for vehicles fitted with fog lamps only. Not available for Plug-in Hybrid Electric Vehicles. Front and rear mudflaps, and deployable side steps, fixed side steps and bright side tubes not available with SVO Design Pack.

SPORTING

Tow Bar Mounted Bike Carrier

The Tow Bar Mounted Bike Carrier features a one hand, quick attach/release tow bar coupling mechanism and can be tilted away from the vehicle, by use of a foot pedal, to allow easy access into the rear tailgate. The tailgate can be opened with carrier in deployed/folded position. Manufactured from aluminium and other lightweight materials, the bike carrier also features a rear lighting and licence plate mount and it is lockable for security. The carrier has a folding/sliding mechanism to allow ease of stowage when not in use. A holder and ratchet function ensure bicycles are safely secured. Maximum load capacity 40kg for 2 bikes and 51kg for 3 bikes.

Sports Roof Box*

Sleek, aerodynamic design sports roof box with a Gloss Black finish which can be mounted on either side of the vehicle for kerbside opening. Internal retention system for skis or other long loads. Lockable for security.

Roof Mounted Bike Carrier*

Roof mounted, lockable bike carrier designed for holding a single bike, up to 20kg.

Aqua Sports Carrier*

Carries a sailboard, canoe or kayak. Includes lockable multi-purpose holder to carry oars or paddles. Tilts to facilitate easy loading/unloading. Features lockable straps and rubber supports to maintain optimum weight distribution whilst protecting the kayak and vehicle from scratches/scuffs. Maximum load capacity 45kg.

Ski/Snowboard Carrier*

Carries four pairs of skis or two snowboards and incorporates slider rails for easy loading, and is also lockable for security. Maximum payload 36kg.



Tow Bar Mounted Bike Carrier



Aqua Sports Carrier



OUTDOOR

Tailgate Event Seating in Ebony Leather

The tailgate event seating is handcrafted from beautiful Windsor, Ebony leather with a highly durable aluminium frame. Stowed in the loadspace, these seats can be quickly and easily fitted to provide comfortable seating for two adults on the lower tailgate, when the vehicle is stationary. The seats come complete with a luxury storage bag with soft lining, which also acts as a useful protective mat to prevent the users' clothes coming into contact with the exterior vehicle surfaces when in use.

Mudflaps

Mudflaps are a popular upgrade for reducing spray and ensuring paintwork is protected from debris and dirt. Designed to complement vehicle exterior styling.

Centre Armrest Cooler/Warmer Box

Food and drinks cooler and warmer that acts as a rear centre armrest. With a leather-covered top, it is held in place by the centre seat belt and powered from the rear auxiliary socket. Ideal for long journeys with the family.

Roof Rails

Roof rails facilitate easy fitment of cross bars for roof carrying. Pre-set positioning points ensure cross bars are fixed in optimum position for weight distribution and dynamics.

Cross Bars*

Elegant, durable Bright finish aluminium cross bars, with T-track design which utilises the full length of the bars, providing space to mount multiple accessories. Aerodynamic profile minimises drag and wind noise. The incremental height when fitted is 93mm.

Luggage Carrier*

Flexible rack system to facilitate roof carrying. Maximum load capacity of accessory is 75kg.



Tailgate Event Seating in Ebony Leather



Centre Armrest Cooler/Warmer Box

TOURING

Public Charging Cable

The public charging cable provides an upgrade from the standard 'home charging' cable, helping to reduce the time required for charging. The 6 metre long, public cable can be used with a universal style A/C wall box (which does not feature a tethered cable), to provide a fast charging solution at home. Alternatively it is compatible with public charging points. When away from home, the cable can be stored in the vehicle's loadspace using a purpose designed storage case and retention system.

iPhone Connect and Charge Dock

The iPhone Connect and Charge Dock has been designed to charge utilising the cup holder space in the central console. When connected, the iPhone's media is accessible and has the ability to be controlled via the integrated infotainment/audio system. The 'cut-out' design of the holder is such that the home button is also accessible for use when parked. The iPhone USB charger can be easily disconnected if the USB connection is required for other use.

Wireless Phone Charging Cupholder

The wireless phone charging cupholder has been designed to charge utilising the cupholder space in the centre console. The holder will accommodate varying phone sizes securely in place. The charger displays an LED light to indicate when charging, and turns off when complete. Fits phones up to 72mm wide.



Wireless Phone Charging Cupholder



Charging Cable



PET PRODUCTS

Pet Loadspace Protection Pack

Designed to provide water resistant protection and easy cleaning of the loadspace from wet and muddy paws. Combines the quilted loadspace liner*, full height luggage partition and spill resistant water bowl.

Pet Transportation Pack

Convenient option to provide a comfortable environment for transporting pets, which can be fitted or removed quickly as and when required. Combines the foldable pet carrier, spill resistant water bowl and loadspace rubber mat.

Pet Care and Access Pack

Taking the effort out of transporting pets, this option ensures everything required is to hand to transport pets in comfort. Combines the full height luggage partition, quilted loadspace liner*, pet access ramp and portable rinse system.

Quilted Loadspace Liner*

A tailored liner which covers and protects the loadspace floor, second row seat backs and loadspace side walls up to window height. Manufactured from a soft quilted fabric, with an integral rubber mat and detachable bumper protector, it is ideal for owners who regularly carry pets in the loadspace of their vehicle.

Foldable Pet Carrier

The foldable pet carrier provides a safe, comfortable environment for the transportation of pets. Manufactured from a durable 600D nylon, the foldable pet carrier has a lightweight metal frame and includes a quilted fabric cushion, net windows and a spring loaded locking mechanism which snaps into place when required. Windsor leather carry handles and corner pieces provide a premium finish, with a side pocket providing a convenient stowage option for other pet accessories or small items.



Pet Loadspace Protection Pack



Pet Transportation Pack

*Not available with PHEV.

THE WORLD OF LAND ROVER

Your Land Rover has been designed and engineered to help you make more of your world. It can take you to places other vehicles simply can't reach in a style that cannot be matched. To celebrate the Land Rover lifestyle, we've put together a range of experiences, publications and the Land Rover Lifestyle Collection. There's a world to explore. Get out there and enjoy it.

EXPERIENCE DRIVES



Bring out your adventurous side and experience Land Rover's legendary capability for yourself. Under the expert guidance of a world-class instructor, head to the most exciting and challenging off-road terrains and take the vehicle to its limits.

landrover.co.uk/experience

ADVENTURE TRAVEL



From the sheer exhilaration of the Arctic ice to the awe-inspiring dunes of Namibia, Land Rover Adventure Travel offers you once-in-a-lifetime experiences that bring the spirit and emotion of our vehicles to life.

landrover.co.uk/adventure

Follow us on:



MANUFACTURING TOURS



This is a unique opportunity to step inside our state-of-the-art manufacturing facilities and see where the latest vehicles are born. Taking you behind the scenes, our expert tour guides will show you how Land Rover combines unrivalled craftsmanship with cutting-edge robotics.

landrover.co.uk/tours

SPECIAL VEHICLE OPERATIONS



Whether it's class-leading luxury, thrilling performance or extreme all-terrain capability, Land Rover excels. Special Vehicle Operations takes this even further. Delivering the absolute pinnacle of Land Rover engineering and design, each vehicle combines peerless refinement with power and cutting-edge technology, which is why the SV badge represents so much.

landrover.co.uk/svo

THE LAND ROVER LIFESTYLE COLLECTION



Our latest range of clothing and lifestyle accessories are crafted with the same design excellence and attention to detail as our vehicles. Inspired by our unique heritage, there is something for the whole family.

landrover.co.uk/branded-goods

ONELIFE MAGAZINE



Free twice a year for your first three years as a Land Rover owner, this award-winning magazine features the best in photography, authoritative journalism and expert insights. Onelife takes you right into the heart of exclusive experiences and extraordinary adventures, whilst keeping you up to date with the latest innovations, design and lifestyle choices.

landrover.co.uk/onelife

Follow us on:



BRAND PARTNERSHIPS



Integrity. Courage. Pride. These are the values that Land Rover shares with its partners. Whether it's the Invictus Games, Virgin Galactic, Rugby World Cup 2019™ or the British and Irish Lions, each one is driven by exceptional people. Those who push their capabilities to the very limits and champion the determination to go above and beyond.

landrover.co.uk/partnerships

HUMANITARIAN PARTNERSHIPS



Since 1954, Land Rover is proud to have supported the incredible humanitarian work of the International Federation of Red Cross and Red Crescent Societies (IFRC). Through vehicles, funding and combined expertise, this ambitious global partnership has helped to transform the lives of over one million people, across four continents.

landrover.co.uk/responsibility



YOUR PEACE OF MIND

CUSTOMER SERVICE

When you bring your Land Rover to us, we use cutting-edge diagnostic equipment to assess all your vehicle's mechanical and electronic systems. Our qualified Technicians use tools specifically designed for our vehicles and only fit genuine Land Rover parts and Gear accessories. A choice of service plans are available which, together with Roadside Assistance, ensures complete peace of mind.

For further details contact your local Land Rover Retailer or search 'Land Rover Ownership'.

LAND ROVER ROADSIDE ASSISTANCE

Land Rover Assistance provides assistance in motoring emergencies, from immobilisation due to breakdown or accident to minor problems such as punctures. You can rely on our roadside assistance, whatever the situation, wherever you happen to be.

For further details please consult your Warranty Benefits handbook, contact your nearest Land Rover Approved Service Centre or search 'Land Rover Roadside Assistance'.

IMPORTANT NOTICE: Jaguar Land Rover Limited is constantly seeking ways to improve the specification, design and production of its vehicles, parts and accessories and alterations take place continually. Whilst every effort is made to produce up-to-date literature, this brochure should not be regarded as an infallible guide to current specifications or availability, nor does it constitute an offer for the sale of any particular vehicle, part or accessory. Distributors and Retailers are not agents of Jaguar Land Rover Limited by any express or implied undertaking or representation.

Images are provided for illustrative purposes only. Colours reproduced on-screen may vary compared to actual finish. The company reserves the right to alter or withdraw any colour finish without notice. Some of these colours may not be obtainable in your country. Please check availability of colours and current specifications with your Land Rover Retailer.

TECHNICAL SPECIFICATION

If not enclosed, please contact your local Land Rover Retailer.

LAND ROVER FINANCIAL SERVICES

Getting the keys to your very own Land Rover has never been so simple. And it's more affordable than you might think. New or used, for personal or business use, we have an option that puts you in complete control.

For further details contact your local Land Rover Retailer or search 'Land Rover Finance'.

FLEET & BUSINESS

Land Rover is dedicated to being the premium manufacturer of choice for fleets and businesses, by providing a highly attractive range of vehicles and exemplary customer service. Distinctive, capable and versatile, all Land Rover vehicles deliver low Total Cost of Ownership through strong residual values, competitive service, maintenance and repair costs, and impressive fuel economy and CO₂ emissions.

We are also committed to providing a totally customer-focused aftersales service, which will ensure every Land Rover vehicle is kept on the road and in top condition, in the easiest and most cost-efficient way for businesses.

Search 'Land Rover Fleet and Business' for full details.

Distributors and retailers are not agents of Jaguar Land Rover Limited and have absolutely no authority to bind Jaguar Land Rover Limited to any express or implied undertaking or representation.

Castrol EDGE Professional exclusively recommended by Land Rover.

Vehicle shown is Autobiography in Byron Blue with optional features fitted.

Jaguar Land Rover Limited

Registered Office: Abbey Road, Whitley,
Coventry CV3 4LF United Kingdom.

Registered in England: Number 1672070

landrover.co.uk

© Copyright Jaguar Land Rover Limited 2019.

1L4052010000BGBEN01P
April 2019/20MY



RANGE ROVER

TECHNICAL SPECIFICATION

2019



ABOVE & BEYOND



ENGINES - SWB

You can select from a choice of diesel, petrol, mild hybrid and plug-in hybrid engines. These engines are designed for clean and efficient combustion and are all equipped with Stop/Start technology and smart regenerative charging.

Configure your Range Rover at landrover.co.uk

TECHNICAL SPECIFICATION

POWERTRAIN	DIESEL				PETROL PHEV		PETROL MHEV		PETROL					
	SDV6		SDV8		P400e		P400		P525		V8 SUPERCHARGED			
Transmission	Automatic		Automatic		Automatic		Automatic		Automatic		Automatic			
Driveline	All Wheel Drive (AWD)		All Wheel Drive (AWD)		All Wheel Drive (AWD)		All Wheel Drive (AWD)		All Wheel Drive (AWD)		All Wheel Drive (AWD)			
Maximum power (HP/rpm)	275 / 3,500-4,250		339 / 3,500		404 / 5,500*		400 / 5,500-6,500		525 / 6,000-6,500		565 / 6,000-6,500			
Maximum torque (Nm/rpm)	625 / 1,500-2,500		740 / 1,750-2,250		640 / 1,500-4,000		550 / 2,000 - 5,000		625 / 2,500-5,500		700 / 3,500-5,000			
Capacity (cc)	2,993		4,367		1,997		2,996		5,000		5,000			
No. of cylinders/Valves per cylinder	6 / 4		8 / 4		4 / 4		6 / 4		8 / 4		8 / 4			
Cylinder layout	Longitudinal V		Longitudinal V		Inline 4		Longitudinal i6		Longitudinal V		Longitudinal V			
Bore/stroke (mm)	84 / 90		84 / 98.5		83 / 92.3		83 / 92.3		92.5 / 93		92.5 / 93			
Compression ratio (:1)	16		16		9.5		10.5		9.5		9.5			
FUEL ECONOMY - NEDC EQUIVALENT NEDCeq**			Class B	Class C	Class B	Class C	Class B	Class C	Class B	Class C	Class B	Class C		
CO ₂ Emissions	Combined	(g/km)	199	204	243	246	72	75	212	216	290	294	298	298
FUEL ECONOMY - WLTP†			TEL - TEH††		TEL - TEH††		TEL - TEH††		TEL - TEH††		TEL - TEH††		TEH††	
WLTP Consumption	Low	mpg (l/100km)	23.9 - 22.3 (11.8 - 12.7)		18.0 - 17.6 (15.7 - 16.1)		-		18.2 - 17.5 (15.5 - 16.2)		12.6 - 12.1 (22.4 - 23.3)		12.3 (22.9)	
	Medium	mpg (l/100km)	31.8 - 28.3 (8.9 - 10.0)		26.5 - 24.5 (10.7 - 11.5)		-		27.4 - 25.8 (10.3 - 10.9)		20.1 - 19.0 (14.0 - 14.9)		18.9 (15.0)	
	High	mpg (l/100km)	36.6 - 33.8 (7.7 - 8.4)		30.4 - 29.7 (9.3 - 9.5)		-		32.2 - 30.0 (8.8 - 9.4)		23.5 - 22.2 (12.0 - 12.7)		22.2 (12.7)	
	Extra High	mpg (l/100km)	31.3 - 29.2 (9.0 - 9.7)		28.9 - 27.1 (9.8 - 10.4)		-		27.0 - 25.2 (10.5 - 11.2)		21.8 - 20.4 (13.0 - 13.8)		20.4 (13.8)	
	Combined	mpg (l/100km)	31.5 - 29.1 (9.0 - 9.7)		26.6 - 25.4 (10.6 - 11.1)		85.1 - 75.7 (3.3 - 3.7)		26.7 - 25.1 (10.6 - 11.3)		20.0 - 18.9 (14.1 - 15.0)		18.9 (14.9)	
EV Range	Combined	miles (km)	-		-		25.0 - 24.0 (41.0 - 39.0)		-		-		-	
FUEL ECONOMY														
Fuel tank capacity - useable litres			86		86		91		104		104		104	
Selective Catalytic Reduction Filter/ Gasoline Particulate Filter (SCR/GPF)			■		■		■		■		■		■	

■ Standard - Not Available.

Class B (19", 20" and 22" wheels with all season tyres, 22" with summer tyres), Class C (21" wheels with all season tyres)

*When combined with electric motor. **The figures provided are NEDCeq calculated from official manufacturer's WLTP tests in accordance with EU legislation. For comparison purposes only. Real world figures may differ. CO₂ figures may vary according to wheel fitment and optional extras fitted. NEDCeq are figures calculated using a Government formula from WLTP figures equivalent to what they would have been under the old NEDCeq test. The correct tax treatment can then be applied. †The figures provided are WLTP. WLTP is the new official EU test used to calculate standardised fuel consumption and CO₂ figures for passenger cars. It measures fuel, energy consumption, range and emissions. This is designed to provide figures closer to real-world driving behaviour. It tests vehicles with optional equipment and with a more demanding test procedure and driving profile.

TECHNICAL SPECIFICATION

PERFORMANCE	DIESEL		PETROL PHEV	PETROL MHEV	PETROL	
	SDV6	SDV8	P400e	P400	P525	V8 SUPERCHARGED
Acceleration (secs) 0-60mph (0-100 km/h)	7.4 (7.9)	6.8 (7.3)	6.4 (6.8)	5.9 (6.3)	5.1 (5.4)	5.1 (5.4)
Maximum speed mph (km/h)	130 (209)	135 (217)	137 (220)	140 (225)	155 (250 ¹)	155 (250 ¹)
ELECTRIC MOTOR DATA						
Maximum Power (kW)	-	-	105	-	-	-
Maximum Torque (Nm)	-	-	275	-	-	-
BRAKES						
Front type	Ventilated disc	Ventilated disc	Ventilated disc	Ventilated disc	Ventilated disc	Ventilated disc
Front diameter (mm)	349	380	380	380	380	380
Rear type	Ventilated disc	Ventilated disc	Ventilated disc	Ventilated disc	Ventilated disc	Ventilated disc
Rear diameter (mm)	325	365	365	365	365	365
Park Brake diameter (mm)			Electric Park Brake (EPB) integrated into brake caliper			
WEIGHTS (kg)²						
Unladen weight (EU) ^{2*}	2,328	2,570	2,577	2,342	2,450	2,591
Unladen weight (DIN) ²	2,253	2,495	2,502	2,267	2,375	2,516
Gross Vehicle Weight (GVW)	3,130	3,290	3,210	3,140	3,160	3,160
TOWING (kg)						
Unbraked trailer	750	750	750	750	750	750
Maximum towing	3,500	3,500	2,500	3,500	3,500	3,500
Maximum coupling point (nose weight)	150	150	100	150	150	150
Maximum vehicle and trailer combination	6,630	6,790	5,710	6,640	6,660	6,660
ROOF CARRYING (kg)						
Maximum roof load (including cross bars)	100	100	100	100	100	100

¹TEL (Test Energy Low) and TEH (Test Energy High) figures are shown as a range under WLTP testing measures. TEL refers to the lowest/most economical figures (with the lightest set of options). TEH refers to the highest/least economical figures (with the heaviest set of options). WLTP legislation dictates that where there is <5g CO₂ variance between TEL and TEH, only the TEH is declared. ²Weights reflect vehicles to standard specifications. Optional extras increase weight.

³Includes a 75kg driver, full fluids and 90% fuel. ⁴Includes full fluids and 90% fuel. ⁵With 22" wheel.

The figures provided are as a result of official manufacturer's tests in accordance with EU legislation. For comparison purposes only. Real world figures may differ. CO₂ and fuel economy figures may vary according to wheel fitment and optional extras fitted. For more information and to configure your vehicle visit landrover.co.uk

ENGINES - LWB

You can select from a choice of diesel, petrol, mild hybrid and plug-in hybrid engines. These engines are designed for clean and efficient combustion and are all equipped with Stop/Start technology and smart regenerative charging.

Configure your Range Rover at landrover.co.uk

TECHNICAL SPECIFICATION

POWERTRAIN			DIESEL		PETROL PHEV		PETROL MHEV		PETROL					
			SDV8		P400e		P400		P525		V8 SUPERCHARGED			
Transmission			Automatic		Automatic		Automatic		Automatic		Automatic			
Driveline			All Wheel Drive (AWD)		All Wheel Drive (AWD)		All Wheel Drive (AWD)		All Wheel Drive (AWD)		All Wheel Drive (AWD)			
Maximum power (HP/rpm)			339 / 3,500		404 / 5,500*		400 / 5,500-6,500		525 / 6,000-6,500		565 / 6,000-6,500			
Maximum torque (Nm/rpm)			740 / 1,750-2,250		640 / 1,500-4,000		550 / 2,000 - 5,000		625 / 2,500-5,500		700 / 3,500-5,000			
Capacity (cc)			4,367		1,997		2,996		5,000		5,000			
No. of cylinders/Valves per cylinder			8 / 4		4 / 4		4 / 4		8 / 4		8 / 4			
Cylinder layout			Longitudinal V		Inline 4		Longitudinal i6		Longitudinal V		Longitudinal V			
Bore/stroke (mm)			84 / 98.5		83 / 92.3		83 / 92.3		92.5 / 93		92.5 / 93			
Compression ratio (:1)			16		9.5		10.5		9.5		9.5			
FUEL ECONOMY - NEDC EQUIVALENT NEDCeq**			Class B		Class C		Class B		Class C		Class B		Class C	
CO ₂ Emissions Combined (g/km)			244		247		72		75		213		217	
FUEL ECONOMY - WLTP†			TEL - TEH††		TEL - TEH††		TEL - TEH††		TEL - TEH††		TEL - TEH††		TEH††	
Low mpg (l/100km)			17.8 - 17.5 (15.8 - 16.2)		-		18.0 - 17.4 (15.7 - 16.2)		12.5 - 12.1 (22.6 - 23.4)		12.3 (22.9)			
Medium mpg (l/100km)			25.7 - 24.0 (11.0 - 11.8)		-		26.8 - 25.7 (10.5 - 11.0)		19.9 - 18.9 (14.2 - 15.0)		18.9 (15.0)			
High mpg (l/100km)			30.2 - 29.6 (9.4 - 9.6)		-		31.5 - 29.8 (9.0 - 9.5)		23.3 - 22.0 (12.1 - 12.8)		22.2 (12.7)			
Extra High mpg (l/100km)			28.3 - 26.6 (10.0 - 10.6)		-		26.4 - 25.0 (10.7 - 11.3)		21.5 - 20.3 (13.1 - 13.9)		20.4 (13.8)			
Combined mpg (l/100km)			26.2 - 25.1 (10.8 - 11.3)		81.9 - 78.9 (3.5 - 3.8)		26.1 - 24.9 (10.8 - 11.4)		19.7 - 18.7 (14.3 - 15.1)		18.9 (14.9)			
EV Range Combined miles (km)			-		25.0 - 24.0 (40.0 - 38.0)		-		-		-			
FUEL ECONOMY														
Fuel tank capacity - useable litres			86		91		104		104		104			
Selective Catalytic Reduction Filter/ Gasoline Particulate Filter (SCR/GPF)			■		■		■		■		■			

■ Standard - Not Available.

Class B (19", 20" and 22" wheels with all season tyres, 22" with summer tyres), Class C (21" wheels with all season tyres)

*When combined with electric motor. **The figures provided are NEDCeq calculated from official manufacturer's WLTP tests in accordance with EU legislation. For comparison purposes only. Real world figures may differ. CO₂ figures may vary according to wheel fitment and optional extras fitted. NEDCeq are figures calculated using a Government formula from WLTP figures equivalent to what they would have been under the old NEDCeq test. The correct tax treatment can then be applied. †The figures provided are WLTP. WLTP is the new official EU test used to calculate standardised fuel consumption and CO₂ figures for passenger cars. It measures fuel, energy consumption, range and emissions. This is designed to provide figures closer to real-world driving behaviour. It tests vehicles with optional equipment and with a more demanding test procedure and driving profile.

TECHNICAL SPECIFICATION

	DIESEL	PETROL PHEV	PETROL MHEV	PETROL	
	SDV8	P400e	P400	P525	V8 SUPERCHARGED
PERFORMANCE					
Acceleration (secs) 0-60mph (0-100 km/h)	7.0 (7.5)	6.5 (6.9)	6.1 (6.5)	5.2 (5.5)	5.2 (5.5)
Maximum speed mph (km/h)	135 (217)	137 (220)	140 (225)	155 (250 ^{*)}	155 (250 ^{*)}
ELECTRIC MOTOR DATA					
Maximum Power (kW)	-	105	-	-	-
Maximum Torque (Nm)	-	275	-	-	-
BRAKES					
Front type	Ventilated disc	Ventilated disc	Ventilated disc	Ventilated disc	Ventilated disc
Front diameter (mm)	380	380	380	380	380
Rear type	Ventilated disc	Ventilated disc	Ventilated disc	Ventilated disc	Ventilated disc
Rear diameter (mm)	365	365	365	365	365
Park Brake diameter (mm)	Electric Park Brake (EPB) integrated into brake caliper				
WEIGHTS (kg)[†]					
Unladen weight (EU) ^{**}	2,658	2,671	2,450	2,518	2,673
Unladen weight (DIN) [‡]	2,583	2,596	2,375	2,443	2,598
Gross Vehicle Weight (GVW)	3,340	3,250	3,170	3,200	3,200
TOWING (kg)					
Unbraked trailer	750	750	750	750	750
Maximum towing	3,400	2,500	3,500	3,500	3,500
Maximum coupling point (nose weight)	150	100	150	150	150
Maximum vehicle and trailer combination	6,740	5,750	6,670	6,700	6,700
ROOF CARRYING (kg)					
Maximum roof load (including cross bars)	100	100	100	100	100

^{††}TEL (Test Energy Low) and TEH (Test Energy High) figures are shown as a range under WLTP testing measures. TEL refers to the lowest/most economical figures (with the lightest set of options). TEH refers to the highest/least economical figures (with the heaviest set of options). WLTP legislation dictates that where there is <5g CO₂ variance between TEL and TEH, only the TEH is declared. [‡]Weights reflect vehicles to standard specifications. Optional extras increase weight.

^{†††}Includes a 75kg driver, full fluids and 90% fuel. ^{‡‡}Includes full fluids and 90% fuel. ^{‡‡‡}With 22" wheel.

The figures provided are as a result of official manufacturer's tests in accordance with EU legislation. For comparison purposes only. Real world figures may differ. CO₂ and fuel economy figures may vary according to wheel fitment and optional extras fitted. For more information and to configure your vehicle visit landrover.co.uk

DIMENSIONS AND CAPABILITIES



Standard Wheelbase (SWB) 2,922mm



Long Wheelbase (LWB) 3,122mm



Standard overall length 5,000mm (Long Wheelbase 5,200mm)

Standard Ride Height

With panoramic roof open (SWB/LWB)
1,874mm/1,880mm
With telematics roof antenna (SWB/LWB)
1,869mm/1,868mm
Access height air suspension setting will
reduce each of the above by 50mm

Headroom

Maximum front/rear headroom with
panoramic roof 1,003mm/1,002mm (991mm LWB)

Legroom

Maximum front legroom 994mm
Maximum rear legroom 997mm (LWB 1,189mm)

Loadspace Capacity*

Height 847mm, Width 1,291mm
Loadspace width between arches 1,120mm
Maximum loadspace volume behind first row (SWB/LWB)
Dry** 1,694/1,856 litres, Wet† 1,943/2,142 litres

Maximum loadspace volume behind second row
Dry** 707/707 litres, Wet† 900/900 litres

Maximum loadspace length behind first row (SWB/LWB)
1,982mm / 2,073mm

Maximum loadspace length behind second row (SWB/LWB)
1,090mm/1,013mm

Executive seat reduces length behind row 2 by 80mm
PHEV reduces height by 46mm

Obstacle Clearance

Off-road height 297mm
Standard ride height 220mm

Turning Circle

Kerb-to-kerb 12.3m (LWB 13.1m)
Wall-to-wall 12.7m (LWB 13.4m)
Turns lock-to-lock 3.03

Wading Depth

Maximum wading depth 900mm††

Width 2,073mm mirrors folded
Width 2,220mm mirrors out



Front wheel track 1,693mm

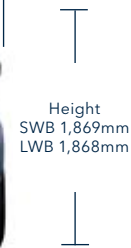

Height
SWB 1,869mm
LWB 1,868mm



Rear wheel track 1,685mm



	A	B	C
Ride Height	Angle Approach	Ramp Angle	Departure Angle
Off-road (SWB/LWB)	34.7°	28.2° / 25.6°	29.0°
Standard (SWB/LWB)	25.5°	21.5° / 20.0°	24.5°



*Rear loadspace capacity is reduced on P400e models. **Dry: Volume as measured with VDA-compliant solid blocks (200mm x 50mm x 100mm). †Wet: Volume as measured by simulating the loadspace filled with liquid.

††Wading depth (25° entry and exit) 750mm, Deep Forging depth (9° entry and exit) 900mm.

Figures shown may differ for 5.0L V8 Supercharged 565HP.

Please note: Figures related to both Standard Wheelbase (SWB) and Long Wheelbase (LWB) models unless stated.